

Bristell B23
AFM COVER DOCUMENT

Office of Airworthiness release

Date:

Name: B. Kölmel

Signature:

Verification Engineer

This document has been independently verified against the requirements listed in Chapter 1 for which it substantiates compliance to the extend addressed in this document. Compliance to 21.A.15 (d) is given in section 2.17 *Minimum Equipment* of the appended AFM.¹

Date:

Name: B. Kölmel

Signature:

Author

Date:

Name: R. Harms G. / M.Basien

Signature:

¹ Acc. GM No 1 to 21.A.15(d) *Application for the approval of operational suitability data – MMEL for ELA1 and ELA2*: For ELA1 and ELA2, the applicant may develop a list of the required equipment to be included in the TCDS and/or AFM/POH. [...]

Aircraft Design Certification GmbH Reichensteinstr.48 69151 Neckargemünd		Bristell B23	Doc-Nr: ADxC-73-001-AFM Issue: A4 Date: 01.10.2020
AFM Cover document			

Amendments

The type design AFM is developed, among others through the evolving AFM used in flight testing of the prototype. To grasp this important step in the AFM development, which includes procedural reviews and pilot information found relevant during flight testing the respective issues are listed also here

Issue	Reason	Date
FT1	First issue, start of flight test	5.7.19
FT2	Incorporation TAC08-24/25: Anti-Flettner Wig/Wag Light Low fuel warning Pitot Heat light	31.7.19
FT3	Overall review and implementation of FT experience	14.01.20
FT4	Corrections M.Scherdel 23.1/27.1 Corrections/Additions system description Note that 45 to 60liter cannot be indicated Fuel qty indication / attitude effect Inclusion performance data from Flight test Information on correct Back-Up battery usage and other failure effects	18.06.20
FT5	TOC formatting Description L3, Autopilot and PFD/MFD Fuel determinatin using dip stick Update caution and warning	15.07.20
Draft	For review by BRM	23.07.2020
A	First Issue	07.08.2020
A1	Incorporation of panel 01 SEPIAC comments / corporate identity formatting	27.08.20
A2	Part21.265(h) statement on cover page missing and AEPS optional equipment (Chapter 2.17)	10.09.2020
A3	Additions: - Incorporation condensed lists warning, caution and advisory lights (new chapter 1.3.2) , according hint in 3.1. - No use of Ap during takeoff/approach landing in section 2.15 Corrections - lower limit engine RPM (yellow range below 1400, not red line) - note to engine manifold yellow range (does not trigger master caution) - control knob placards (now with operation direction indication) - graph <u>usable</u> fuel vs. filling height (graph ends at 59, not 60 liter)	23.09.2020
A4	EASA: Clarification that autopilot modes for performance based navigation is not certified with this aircraft (added limitation statement and correct of Note in Autopilot chapter)	01.10.2020

References

/1/ ADxC-73-C1-011_A AEPS Parachute installation manual

Other references, such as certification reports containing speeds and other relevant data are given next to the relevant text are in the word document (.docx) as “comments”. There also reasoning for information and data is given. This is not visible in the standard print format.

Aircraft Design Certification GmbH Reichensteinstr.48 69151 Neckargemünd		Bristell B23	Doc-Nr: ADxC-73-001-AFM Issue: A4 Date: 01.10.2020
AFM Cover document			

1 General

This cover document belongs to the AFM with the same document number.
 According to ADC DOH process, Section ACP.3.12 the appended AFM is compiled.

AFM Cover document

2 Requirement analysis

CS-23 Amdt. 5	AMC CS-VLA Amdt. 1 / ASTM	Requirement Text	Compliance summary as addressed in this report
23.2605 23.2620	ASTMF2316- 12 10.1	Operating limitations 10.1 Operating limitations must be prescribed to ensure proper operation of the parachute system.	AEPS side: ref. /1/ Aircraft side: Operating limitation are stated in the appended AFM, markings used where necessary. Section 2.15, 2.16
23.2525 23.2500 23.2615	VLA.1303	Flight and navigation instruments The following are required flight and navigational instruments: (a) An airspeed indicator; (b) An altimeter; (c) A magnetic direction indicator.	Airspeed, altitude and magnetic direction indication are displayed on the L3 EIS and The Garmin MFD. Both belong to the minimum equipment. The information of minimum required equipment is made available to the pilot in the appended AFM Section 6.6
23.2325 23.2430 23.2510 23.2605 23.2615 23.2610	VLA.1337	Powerplant instruments [...] (b) Fuel quantity indicator. There must be a means to indicate to the pilot the quantity of fuel in each tank during flight. In addition - [...]	[...] (b) The EMS provides fuel quantity indication (for each tank separately). Additionally an independent "low fuel warning" is present for each tank. The trigger point of the warning is flight tested to 10liter, but conservatively published to 6 liter which corresponds to a safe remaining flight time of appx. 15 min on the respective tank which is reflected in the AFM section 2.6, 4.4.9, 7.4.1. [...]
23.2610 23.2170	VLA.1501	General (a) Each operating limitation specified in CS-VLA 1505 to 1525 and other limitations and information necessary for safe operation must be established. (b) The operating limitations and other information necessary for safe operation must be made available to the pilot as prescribed in CSCS 1541 to 1589.	(a) 1525 and other limitations and information necessary for safe operation are established. (b) The operating limitations and other information necessary for safe operation are made available to the crew members as prescribed in CS-VLA 1541 to 1589 AFM section 2.
23.2170 23.2610	VLA.1505	Airspeed limitations (a) The never-exceed speed VNE must be established so that it is – (1) Not less than 0.9 times the minimum value of VD allowed under CS-VLA 335; and (2) Not more than the lesser of – (i) 0.9 VD established under CSVLA 335; or (ii) 0.9 times the maximum speed shown under CS-VLA 251. (b) The maximum structural cruising speed VNO must be established so that it is – (1) Not less than the minimum value of VC allowed under CS-VLA 335; and (2) Not more than the lesser of –	(a) VNE is established to: VNE = 156.5KEAS = 157KIAS (1) VNE is not less than 0.9 times the minimum value of VD under VLA.335 which is $0.9 \cdot 173.9 \text{ KEAS} = 156.5 \text{ KEAS}$ (2) VNE is not more then the lesser of: (i) 0.9VD established (selected) under CS-VLA 335 = $0.9 \cdot 173.9 = 156.5 \text{ KEAS}$ (ii) 0.9 the maximum speed shown under CS-VLA 251 = $0.9 \cdot 175 = 157.5 \text{ EAS}$

AFM Cover document

		(i) VC established under CSVLA 335; or (ii) 0.89 VNE established under sub-paragraph (a) of this paragraph.	(b) VNO is established to: VNO = 135KEAS = 136KIAS (1) VNO is not less than the minimum value of VC under CS-VLA 335 which is 117KEAS (2) VNO is not more than the lesser of: (i) VC established (selected) under VLA.335 = 135KEAS (ii) 0.89 VNE established under (a) = $0.89 \cdot 157 \text{KEAS} = 139.7 \text{KEAS}$ Speed limitations are contained in AFM Section 2.2
23.2160 23.2170	VLA.1507	Manoeuvring speed The manoeuvring speed VA, determined under CS-VLA 335, must be established as an operating limitation.	The maneuvering speed VA = 98KEAS = 99KIAS is established under CS-VLA.335 and given in the AFM Section 2.2.
23.2610 23.2170	VLA.1511	Flap extended speed (a) The flap extended speed VFE must be established so that it is – (1) Not less than the minimum value of VF allowed in CS-VLA 345 and 457; and (2) Not more than the lesser of – (i) VF established under CSVLA 345; or (ii) VF established under CSVLA 457. (b) Additional combinations of flap setting, airspeed, and engine power may be established if the structure has been proven for the corresponding design conditions.	(a) The flap extended speed VFE = 81KEAS = 82KIAS is established and VFE = 81KEAS is no less than the minimum allowed under - CS-VLA 345 which requires a minimum of 68.6KEAS - CS-VLA 457 which requires a minimum of 68.6KEAS VFE is not more than the lesser of: (i) VF established (selected) under CS-VLA 335 = 68.6KEAS (ii) VF established (selected) under CS-VLA 457 = 68.6KEAS (b) No additional combinations have been established Speed limitation AFM section 2.2
23.2610 23.2170	VLA.1519	Weight and centre of gravity The weight and centre of gravity limitations determined under CS-VLA 23 must be established as operating limitations.	The published limits are MTOW 750kg and CG 1712 to 1840mm aft datum for all weights. Limitations are made available to the pilot as operating limitations in the appended AFM Section 2.7 and 2.8.
23.2445 23.2610	VLA.1521	Powerplant limitations (a) General. The powerplant limitations prescribed in this paragraph must be established so that they do not exceed the corresponding limits for which the engine or propeller is type certificated. (b) Take-off operation. The Powerplant take-off operation must be limited by – (1) The maximum rotational speed power; (2) The maximum allowable manifold pressure for aeroplanes equipped with a variable pitch propeller or supercharger; (3) The time limit for the use of the power or thrust corresponding to the limitations established in sub-paragraphs (b)(1) and (b)(2) of this paragraph; and (4) If the time limit in sub-paragraph (b)(3) of this paragraph exceeds two minutes, the maximum allowable cylinder head (as applicable), liquid coolant, and oil temperatures. (c) Continuous operation. The continuous operation must be limited by –	Powerplant limitations established under this paragraphs do not exceed the limits for the type certified engine, nor of the propeller Powerplant limitations are contained in AFM Section 2.4 and 2.5

AFM Cover document

		<p>(1) The maximum rotational speed; (2) The maximum allowable manifold pressure for aeroplanes equipped with a variable pitch propeller or supercharger; (3) The maximum allowable cylinder head, oil, and liquid coolant temperatures. (d) Fuel grade. The minimum fuel grade must be established so that it is not less than that required for the operation of the engine within the limitations in sub-paragraphs (b) and (c) of this paragraph.</p>	
23.2610	VLA.1525	<p>Kinds of operation The kinds of operation to which the aeroplane is limited are established by the category in which it is eligible for certification and by the installed equipment.</p>	<p>The aircraft is limited to day and night VFR operations, flight in icing conditions prohibited. The limitation is made available to the pilot by means of the appended AFM and the placard required under 23.1559 (c). AFM Section 2.16, placard on left instrument panel</p>
23.2620	VLA.1581	<p>General (a) Furnishing information. A Flight Manual must be furnished with each aeroplane. There must be an appropriate location for stowage of the Flight Manual aboard the aeroplane and each Flight Manual must contain the following: (1) Information required in CS-VLA 1583 to 1589 including the explanation necessary for their proper use and the significance of the symbols used. (2) Other information that is necessary for safe operation because of design operating or handling characteristics, including the effect of rain and insects accumulation on flight characteristics and performances as determined under CS-VLA 21 (d). (3) A list of effective pages, with identification of those containing approved information according to sub-paragraph (b) of this paragraph. (b) Approved information. Each part of the Flight Manual containing information prescribed in CS-VLA 1583 to 1587 (a) must be limited to such information and must be approved, identified and clearly distinguished from each other part of the Flight Manual. All Manual material must be of a type that is not easily erased, disfigured or misplaced, and it must be in the form of individual sheets capable of being inserted in a Manual provided by the applicant, or in a folder or in any other permanent form. (c) Non-approved information. Nonapproved information must be presented in a manner acceptable to the Agency. (d) Units. The units of measurement used in the Flight Manual must be the same as those used on the indicators.</p>	<p>(a) A Flight Manual is furnished with each aeroplane. Stowage provisions for the flight manual is in pockets on the side panel (AFM section 7.6). All information required by this subparagraph is presented in the AFM. (b) Parts of the AFM containing approved information (according to this requirement) are: Chapter 2 Limitations Chapter 3 Emergency procedures Chapter 5.2 Approved data: Chapter 5.2.4 Take off distance Chapter 5.2.5 Landing distance Chapter 5.2.6 Climb performance Specific Identification and distinction of these chapters and pages as “approved” by means of “Approved-page “ indication in the footer, all other pages carry “non-approved-page” marking. (c) All non approved information in the AFM is presented in a manner similar to the approved information. Information contained therein is prepared and checked according applicable procedures outlined in the ADxC DOH which is documented in this cover document. (d) Units used in AFM correlate to those on indicators and placards.</p>

AFM Cover document

23.2620	VLA.1585	<p>Operating data and procedures Information concerning normal and emergency procedures and other pertinent information necessary for safe operation must be furnished, including –</p> <ul style="list-style-type: none"> (a) The stall speed in the various configurations. (b) Any loss of altitude more than 30 m or any pitch attitude more than 30° below the horizon occurring during the recovery part of the manoeuvre prescribed in CS-VLA 201. (c) Any loss of altitude of more than 30 m occurring in the recovery part of the manoeuvre prescribed in CS-VLA 203. (d) Recommended recovery procedure to recover from an inadvertent spin. (e) Special procedures to start the engine in flight, if necessary. (f) Information on the total quantity of usable fuel, and conditions under which the full amount of usable fuel in each tank can safely be used. 	<p>Airplane flight manual contains all information required by this paragraph.</p> <ul style="list-style-type: none"> (a) Section 5.2.2 (b) Section 5.2.2 (c) Section 5.2.2 (d) Section 3.7.2 (e) Section 3.3 (f) Section 2.13
23.2620	VLA.1587	<p>Performance information</p> <ul style="list-style-type: none"> (a) General. For each aeroplane, the following information must be furnished <ul style="list-style-type: none"> (1) The take-off distance determined under CS-VLA 51, the airspeed at the 15 m height, the aeroplane configuration (if pertinent), the kind of surface in the tests, and the pertinent information with respect to cowl flap position, use of flight path control devices, and use of the landing gear retraction system. (2) The landing distance determined under CS-VLA 75, the aeroplane configuration (if pertinent), the kind of surface used in the tests, and the pertinent information with respect to flap position and the use of flight path control devices. (3) The steady rate or gradient of climb determined under CS-VLA 65 and 77, the airspeed, power, and the aeroplane configuration. (4) The calculated approximate effect on take-off distance (sub-paragraph (a)(1) of this paragraph), landing distance (subparagraph (a)(2) of this paragraph), and steady rates of climb (sub-paragraph (a)(3) of this paragraph), of variations in altitude and temperature. (See AMC VLA 1587(a)(4).) (5) The maximum atmospheric temperature at which compliance with the cooling provisions of CS-VLA 1041 to 1047 is shown. (b) Skiplanes. For skiplanes a statement of the approximate reduction in climb performance may be used instead of complete new data for skiplane configuration, if - <ul style="list-style-type: none"> (1) The landing gear is fixed in both landplane and skiplane configurations; (2) The climb requirements are not critical; and (3) The climb reduction in the skiplane configurations is small (0.15 to 0.25 m/s (30 to 50 feet per minute)). (c) Information concerning normal procedures <ul style="list-style-type: none"> (1) The demonstrated crosswind velocity and procedures and information pertinent to operation of the aeroplane in crosswinds, and (2) The airspeeds, procedures, and information 	<p>Airplane flight manual contains all information required by this paragraph.</p> <ul style="list-style-type: none"> (a-1) Section 5.2.4 (a-2) Section 5.2.5 (a-3) Section 5.2.3 (a-4) Section 5.2.4 and 5.2.5 (a-5) Section 2.15 (b) N/A

AFM Cover document

		<p>pertinent to the use of the following airspeeds:</p> <p>(i) The recommended climb speed and any variation with altitude.</p> <p>(ii) VX (speed for best angle of climb) and any variation with altitude.</p> <p>(iii) The approach speeds, including speeds for transition to the balked landing condition.</p> <p>(d) An indication of the effect on take-off distance of a grass surface as determined from at least one take-off measurement on short mown dry grass must be furnished.</p>	
23.2620	VLA.1589	<p>Loading information The following loading information must be furnished:</p> <p>(a) The weight and location of each item of equipment installed when the aeroplane was weighed under CS-VLA 25.</p> <p>(b) Appropriate loading instructions for each possible loading condition between the maximum and minimum weights determined under CS-VLA 25 that can result in a centre of gravity beyond –</p> <p>(1) The extremes selected by the applicant;</p> <p>(2) The extremes within which the structure is proven; or</p> <p>(3) The extremes within which compliance with each functional requirement is shown.</p>	Airplane flight manual contains all information required by this paragraph in Section 6
23.2325 23.2335	VLA.857	<p>Electrical bonding [...] (c) There must be provisions for electrically bonding the aeroplane to the ground fuelling equipment.</p>	[...] (c) Grounding the airplane during fuelling is achieved by attaching grounding cable to exhaust, as stated in the appended AFM Section 7.10.
23.2100	VLA.871	<p>Levelling means There must be means for determining when the aeroplane is in a level position on the ground.</p>	The upper rivet row below the canopy frame serves as levelling mean to determine ground level attitude and is published in the appended AFM for this purpose, Section 6.2.
23.2620	VLA_NVFR.1 583	<p>Operating limitations</p> <p>(a) Airspeed limitations. The following information must be furnished</p> <p>(1) Information necessary for the marking of the airspeed limits on the indicator, as required in CS-VLA 1545 and the significance of the colour coding used on the indicator.</p> <p>(2) The speeds VA, VLO, VLE where appropriate.</p> <p>(b) Weights. The following information must be furnished:</p> <p>(1) The maximum weight.</p> <p>(2) Any other weight limits, if necessary.</p> <p>(c) Centre of gravity. The established c.g. limits required by CS-VLA 23 must be furnished.</p> <p>(d) Manoeuvres. Authorised manoeuvres established in accordance with CS-VLA 3.</p> <p>(e) Flight load factors. Manoeuvring load factors: the following must be furnished:</p> <p>(1) The factors corresponding to point A and point C of figure 1 of CS-VLA 333 (b), stated to be applicable at VA.</p> <p>(2) The factors corresponding to point D and point E of figure 1 of CS-VLA 333 (b) to be applicable at VNE.</p>	Airplane flight manual contains all information required by this paragraph. (a) Section 2.2. and 2.3 (b) Section 2.7 (c) Section 2.8 (d) Section 2.9 (e) Section 2.10 (f) Section 2.12 (g) Section 2.4 and 2.5 (h) Section 2.16

Aircraft Design Certification GmbH Reichensteinstr.48 69151 Neckargemünd	 adxc aircraft design certification gmbh	Bristell B23	Doc-Nr: ADxC-73-001-AFM Issue: A4 Date: 01.10.2020
AFM Cover document			

	<p>(3) The factor with wing flaps extended as specified in CS-VLA 345.</p> <p>(f) The kinds of operation (Day-VFR or Day- and Night-VFR, whichever is applicable) in which the aeroplane may be used, must be stated. The minimum equipment required for the operation must be listed.</p> <p>(g) Powerplant limitations. The following information must be furnished:</p> <p>(1) Limitation required by CS- VLA 1521.</p> <p>(2) Information necessary for marking the instruments required by CS-VLA 1549 to 1553.</p> <p>(3) Fuel and oil designation.</p> <p>(4) For two-stroke engines, fuel/oil ratio.</p> <p>(h) Placards. Placards required by CS-VLA 1555 to 1561 must be presented.</p>	
--	---	--

3 Involved personnel

Name	assignment	function	Issue
Petr Jovorsky	DE at BRM	Original manual, UL series-converted to Typ design format	Draft
		Corporate formatting	A 27.08.20
Marcus Basien	HOD, FTE, Test pilot ADxC	Co-Autor of document TAC-review	FT1..FT5, A
Lyssandre Rammos	Lead FTE, Test pilot, ADxC	Chapter 5 Cross check TAC-review	FT1..FT5, A
Malte Höltken	Test pilot ADxC	Proof reading	FT3
Markus Scherdel	Test pilot ADxC	Proof reading	FT3
Boris Koelmel	HOA, Test pilot ADxC	CVE	A



BRISTELL B23

AIRCRAFT FLIGHT MANUAL



The technical content of this document is approved under the authority of the DOA ref. EASA. 21J.411

Document No.: ADXC-73-001-AFM	Non-approved page	Revision: A
		Date of Issue: 01.10.2020



AIRCRAFT FLIGHT MANUAL

BRISTELL B23

INTENTIONALLY LEFT BLANK

Document No.: ADXC-73-001-AFM	Non-approved page	Revision: A
	II	Date of Issue: 01.10.2020



AIRCRAFT FLIGHT MANUAL

BRISTELL B23

Model: BRISTELL B23

Serial No:

Registration:

Document No.: ADXC-73-001-AFM

Date of Issue: 01.10.2020

For approval reference of pages identified as “Approved page” refer to Section 0.1 record of revisions

This aeroplane is to be operated in compliance with information and limitations contained herein.

Document No.: ADXC-73-001-AFM	Non-approved page	Revision: A
		Date of Issue: 01.10.2020

Contact Data for Occurrences

BRM AERO s.r.o.

Letecká 255
686 04 Kunovice
Czech republic

Tel.: +420 773 984 338
Mail: info@brmaero.com
www.bristell.com

Aircraft Design Certification GmbH

Reichensteinstrasse 48
69151 Neckargemünd
Germany

Tel.: +49 176 322 698 25
Mail: info@aircraftdc.de
www.aircraftdc.de

Document No.: ADXC-73-001-AFM	Non-approved page	Revision: A
	II	Date of Issue: 01.10.2020

SECTION 0

0 TECHNICAL INFORMATION

<i>0.1</i>	<i>Record of revisions.....</i>	<i>0-1</i>
<i>0.2</i>	<i>List of Effective Pages.....</i>	<i>0-2</i>
<i>0.3</i>	<i>Table of Contents.....</i>	<i>0-5</i>
<i>0.4</i>	<i>Symbols, Abbreviations, Terminology.....</i>	<i>0-6</i>

0.1 *Record of revisions*

Any revision of the present manual, except actual weighing data, must be recorded in the following table and in case of approved Sections endorsed by the Agency.

The new or amended text in the revised pages will be indicated by a black vertical line in the left hand margin, and the Revision No. and the date will be shown on the bottom left hand side of the page.

Issue	Affected Pages	Date	Change/Reason	Approval Reference
A	all	01.10.2020	First issue	

Document No.: ADXC-73-001-AFM	Non-approved page	Revision: A
	0-1	Date of Issue: 01.10.2020

0.2 List of Effective Pages

Section	Page	Appr.	Rev.	Date	Section	Page	Appr.	Rev.	Date
	I		A	01.10.2020		2-4	X	A	01.10.2020
	II		A	01.10.2020		2-5	X	A	01.10.2020
						2-6	X	A	01.10.2020
	i		A	01.10.2020		2-7	X	A	01.10.2020
	ii		A	01.10.2020		2-8	X	A	01.10.2020
						2-9	X	A	01.10.2020
0	0-0		A	01.10.2020		2-10	X	A	01.10.2020
	0-1		A	01.10.2020		2-11	X	A	01.10.2020
	0-2		A	01.10.2020		2-12	X	A	01.10.2020
	0-3		A	01.10.2020		2-13	X	A	01.10.2020
	0-4		A	01.10.2020		2-14	X	A	01.10.2020
	0-5		A	01.10.2020		2-15	X	A	01.10.2020
	0-5		A	01.10.2020		2-16	X	A	01.10.2020
	0-6		A	01.10.2020		2-17	X	A	01.10.2020
	0-7		A	01.10.2020					
1	1-0		A	01.10.2020	3	3-0	X	A	01.10.2020
	1-1		A	01.10.2020		3-1	X	A	01.10.2020
	1-2		A	01.10.2020		3-2	X	A	01.10.2020
	1-3		A	01.10.2020		3-3	X	A	01.10.2020
	1-4		A	01.10.2020		3-4	X	A	01.10.2020
	1-5		A	01.10.2020		3-5	X	A	01.10.2020
	1-6		A	01.10.2020		3-6	X	A	01.10.2020
	1-7		A	01.10.2020		3-7	X	A	01.10.2020
	1-8		A	01.10.2020		3-8	X	A	01.10.2020
	1-9		A	01.10.2020		3-9	X	A	01.10.2020
	1-10		A	01.10.2020		3-10	X	A	01.10.2020
	1-11		A	01.10.2020		3-11	X	A	01.10.2020
						3-12	X	A	01.10.2020
2	2-0	X	A	01.10.2020		3-13	X	A	01.10.2020
	2-1	X	A	01.10.2020		3-14	X	A	01.10.2020
	2-2	X	A	01.10.2020		3-15	X	A	01.10.2020
	2-3	X	A	01.10.2020					

Document No.: ADXC-73-001-AFM	Non-approved page	Revision: A
	0-2	Date of Issue: 01.10.2020

Section	Page	Appr.	Rev.	Date	Section	Page	Appr.	Rev.	Date	
4	4-0		A	01.10.2020	6	6-0		A	01.10.2020	
	4-1		A	01.10.2020		6-1		A	01.10.2020	
	4-2		A	01.10.2020		6-2		A	01.10.2020	
	4-3		A	01.10.2020		6-3		A	01.10.2020	
	4-4		A	01.10.2020		6-4		A	01.10.2020	
	4-5		A	01.10.2020		6-5		A	01.10.2020	
	4-6		A	01.10.2020		6-6		A	01.10.2020	
	4-7		A	01.10.2020		6-7		A	01.10.2020	
	4-8		A	01.10.2020						
	4-9		A	01.10.2020						
	4-10		A	01.10.2020						
4-11		A	01.10.2020	7	7-0		A	01.10.2020		
4-12		A	01.10.2020		7-1		A	01.10.2020		
4-13		A	01.10.2020		7-2		A	01.10.2020		
4-14		A	01.10.2020		7-3		A	01.10.2020		
4-15		A	01.10.2020		7-4		A	01.10.2020		
4-16		A	01.10.2020		7-5		A	01.10.2020		
4-17		A	01.10.2020		7-6		A	01.10.2020		
					7-7		A	01.10.2020		
5	5-0		A	01.10.2020	7-8		A	01.10.2020		
	5-1		A	01.10.2020	7-9		A	01.10.2020		
	5-2		A	01.10.2020	7-10		A	01.10.2020		
	5-3		A	01.10.2020	7-11		A	01.10.2020		
	5-4	X	A	01.10.2020	7-12		A	01.10.2020		
	5-5	X	A	01.10.2020	7-13		A	01.10.2020		
	5-6	X	A	01.10.2020	7-14		A	01.10.2020		
	5-7	X	A	01.10.2020	7-15		A	01.10.2020		
	5-8	X	A	01.10.2020	7-16		A	01.10.2020		
	5-9	X	A	01.10.2020	7-17		A	01.10.2020		
	5-10		A	01.10.2020	7-18		A	01.10.2020		
	5-11		A	01.10.2020	7-19		A	01.10.2020		
	5-12		A	01.10.2020	7-20		A	01.10.2020		
	5-13		A	01.10.2020	7-21		A	01.10.2020		
	5-14		A	01.10.2020	7-22		A	01.10.2020		
	5-15		A	01.10.2020	7-23		A	01.10.2020		
	5-16		A	01.10.2020	7-24		A	01.10.2020		
5-17		A	01.10.2020	7-25		A	01.10.2020			
				7-26		A	01.10.2020			
				7-27		A	01.10.2020			
				7-28		A	01.10.2020			
				7-29		A	01.10.2020			

Section	Page	Appr.	Rev.	Date	Section	Page	Appr.	Rev.	Date
	7-30		A	01.10.2020					
	7-31		A	01.10.2020					
	7-32		A	01.10.2020	9	9-1		A	01.10.2020
	7-33		A	01.10.2020		9-2		A	01.10.2020
	7-34		A	01.10.2020		9-3		A	01.10.2020
	7-35		A	01.10.2020					
	7-36		A	01.10.2020					
	7-37		A	01.10.2020					
	7-38		A	01.10.2020					
	7-39		A	01.10.2020					
	7-40		A	01.10.2020					
	7-41		A	01.10.2020					
	7-42		A	01.10.2020					
	7-43		A	01.10.2020					
	7-44		A	01.10.2020					
	7-45		A	01.10.2020					
	7-46		A	01.10.2020					
	7-47		A	01.10.2020					
	7-48		A	01.10.2020					
	7-49		A	01.10.2020					
	7-50		A	01.10.2020					
	7-51		A	01.10.2020					
8	8-1		A	01.10.2020					
	8-2		A	01.10.2020					
	8-3		A	01.10.2020					
	8-4		A	01.10.2020					
	8-5		A	01.10.2020					

0.3 *Table of Contents*

Sections:

0	Technical Information	0-0
1	General	1-0
2	Limitations.....	2-0
3	Emergency procedures	3-0
4	Normal procedures	4-0
5	Performance.....	5-0
6	Weight and balance	6-0
7	Aeroplane and system description.....	7-0
8	Aeroplane handling, servicing and maintenance.....	8-0
9	Supplements	9-0

0.4 Symbols, Abbreviations, Terminology

AEPS	Aircraft emergency parachute system
AGL	Above ground level
C.G.	Centre of gravity
CHT	Cylinder head temperature
EASA	European Union Aviation Safety Agency
EGT	Exhaust gas temperature
EIS	Engine indication system (used to describe the physical unit collecting engine sensor data)
ELT	Emergency location transmitter
EMS	Engine monitoring system (used to describe the pilot interface and indication)
ISA	International standard Atmosphere
MAC	Mean aerodynamic chord
MCP	Maximum continuous power
MFD	Multifunction display
MTOP	Maximum take-off power
MTOW	Maximum take-off weight
NAV/COM	Combined VOR navigation and communication radio unit
OAT	Outside air temperature
PED	Personal electronic device
PFD	Primary flight display
RPM	Revolutions per minute (used synonym with engine speed, not synonym with propeller speed)
SL	Sea level
TOW	Take-off weight
VOR	Very high frequency (VHF) omnidirectional radio range
WOT	Wide open Throttle
XPDR	Transponder

Speeds:

CAS	Calibrated airspeed
EAS	Equivalent airspeed
IAS	Indicated airspeed
TAS	True airspeed
V _A	Design manoeuvring speed
V _{FE}	Maximum speed with flaps extended
V _H	Maximum level flight speed
V _{NE}	Never exceed speed
V _{NO}	Maximum structural cruising speed
V _S	Stall speed
V _{SO}	Stall speed in landing configuration
V _X	Speed for best angle of climb
V _Y	Speed for best rate of climb

NOTE

For all practical purposes for this airplane EAS=CAS.

Document No.: ADXC-73-001-AFM	Non-approved page	Revision: A
	0-7	Date of Issue: 01.10.2020

SECTION 1

1 GENERAL

1.1	<i>Introduction</i>	<i>1-1</i>
1.2	<i>Certification basis</i>	<i>1-1</i>
1.3	<i>Warnings, cautions and notes</i>	<i>1-2</i>
1.3.1	AFM warnings, cautions and notes	1-2
1.3.2	Pilot warnings, cautions and advisory lights	1-3
1.4	<i>Descriptive data.....</i>	<i>1-8</i>
1.4.1	Dimensions External	1-9
1.4.2	Dimensions Internal	1-9
1.5	<i>Three-view drawing.....</i>	<i>1-10</i>

Document No.: ADXC-73-001-AFM	Non-approved page	Revision: A
	1-0	Date of Issue: 01.10.2020

1.1 **Introduction**

The aeroplane Flight Manual has been prepared to provide pilots and operators with information for the safe and efficient operation of this very light aeroplane.

This manual includes the information required to be supplied to the pilot according the certification basis

It also contains supplemental data supplied by the aeroplane manufacturer.

1.2 **Certification basis**

This type of aircraft has been approved by the European Union Aviation Safety Agency in accordance with

CS-23 Amdt. 5 with AMC No. 3 (CS-VLA, Amendment 1)

and the

Type Certificate No. :

has been issued on (date):

Category of Airworthiness: Normal

Noise Certification Basis: CS-36 Amendment 4

The determined noise emission value according ICAO Annex 16 Chapter 10 Vol. 1. is **69.2dB(A)**.

Document No.: ADXC-73-001-AFM	Non-approved page	Revision: A
	1-1	Date of Issue: 01.10.2020

1.3 **Warnings, cautions and notes**

1.3.1 AFM warnings, cautions and notes

The following definitions apply to warnings, cautions and notes used in the flight manual.

WARNING

Means that the non-observation of the corresponding procedure leads to an immediate or important degradation of the flight safety.

CAUTION

Means that the non-observation of the corresponding procedure leads to a minor or to a more or less long term degradation of the flight safety.

NOTE

Draws the attention to any special item not directly related to safety but which is important or unusual.

Document No.: ADXC-73-001-AFM	Non-approved page	Revision: A
	1-2	Date of Issue: 01.10.2020

1.3.2 Pilot warnings, cautions and advisory lights

The colour coding for pilot indications follows the aviation standard:

- RED: immediate danger, immediate pilot action
- AMBER: condition acceptable only for limited time
- GREEN: normal operation
- Any other: Information

The following table gives an overview of implication and required procedures to react and interpret the indications.

Light	Display	Condition	Implication/ Procedure
RED, EMS master warning	CHT	Cylinder Head Temp.: max. limit exceeded	<u>AFM 4.4.9 Climb:</u> Reduce climb angle / increase airspeed
	EGT	Exhaust Gas Temp.: max. limit exceeded	<u>AFM 4.4.11 Descent:</u> Reduce RPM
	OIL	Oil Temperature: max. limit exceeded	<u>AFM 4.4.9 Climb:</u> Reduce climb angle / increase airspeed
	OIL PRESS	Oil Pressure: min. limit exceeded	<u>AFM 3.8.3 Loss of oil pressure:</u> 1. Reduce engine power setting to the minimum necessary 2. Check oil temperature; if high: - reduce oil temp if temperature decrease does not result in improvement: - land as soon as practical

Light	Display	Condition	Implication/ Procedure
cont... RED, EMS master warning	OIL PRESS	Oil Pressure: max. limit exceeded	<u>AFM 3.8.4 High oil pressure:</u> 1. Reduce engine power setting to the minimum necessary 2. engine RPM (propeller) - reduce <5000 3. Speed - 67 KIAS 4. <u>Land as soon as practical</u> <u>3.6.2</u> <u>AFM 4.4.3 Engine starting:</u> Oil pressure with a cold engine could be high. A maximum of 7bar is acceptable
	MAN PRESS	Manifold Pressure: max. limit exceeded	Reduce power / Throttle <i>Note: exceedance physically only possible in very high ambient pressure condition (ambient press > 1050hPa), sensor failure should be considered.</i>
	FUEL PRESS	Fuel Pressure: min. limit exceeded	Transient fuel pressure below 0.15bar acceptable for maximum 5sec Switch fuel pump ON
	FUEL PRESS	Fuel Pressure: max. limit exceeded	Switch fuel pump OFF Switch fuel tank (L/R) Reduce RPM
	RPM	Engine Speed (RPM): max. limit exceeded	Reduce RPM (propeller) Reduce Throttle (power)
	FUEL L FUEL R	Fuel Quantity: Less than unusable fuel amount in respective tank	Switch fuel tank Land as soon as practical Prepare for precautionary landing <u>Chapter 3.6.2</u>

Light	Display	Condition	Implication/ Procedure
cont... RED, EMS master warning	VOLTS	Electric system voltage below 8 Volt	Check ALT1/ALT2 ON Check AMP positive (charging the system) USB power - remove load switch off all non-essential electrical equipment see <u>AFM 3.8.5 Alternator failure / use of back-up battery</u> <u>3.8.6 Bus system failure</u>
	VOLTS	Electric system voltage above 15 Volt	Reduce engine RPM (propeller and power) Alt1 switch – OFF (if not sufficient) Alt2 switch – OFF (if not sufficient) <u>See AFM 3.8.7 Overvoltage</u>
	AMPS	Battery current below -20A (discharge)	If positive charge (Amps) cannot be maintained on one alternator: Consider use of back-up battery see 3.8.5 - Land as soon as practical
	AMPS	Battery current above +25A (charge)	MASTER Switch OFF
AMB. EMS master caution	OIL TEMP	Oil Temperature: caution limit exceeded	<u>Engine starting:</u> Engine speed <2500RPM <u>Cruise</u> Increase power / reduce RPM
	FUEL L	Fuel Quantity: Less than 10liter in respective tank	Switch tank (L/R)
	FUEL R		Check flight planning

Light	Display	Condition	Implication/ Procedure
cont... AMB. EMS master caution	VOLTS	Electric system voltage below 11 Volt	Check ALT1/ALT2 ON Check AMP positive (charging the system) USB power - remove load switch off all non-essential electrical equipment
	AMPS	Battery current below -10 Amp (discharge)	Observe; if continuous: Check ALT1/ALT2 ON Check AMP positive (charging the system) USB power - remove load switch off all non-essential electrical equipment
	AMPS	Battery current above +10Amp (charge)	Observe; if continuous: MASTER Switch OFF
	ALT 1	Alternator 1 does not deliver	Switch ALT 1 ON, Check ALT 1 and ALT 1 CTRL CB If the caution indication persists: ALT 1 OFF
	ALT 2	Alternator 2 does not deliver	Switch ALT 2 ON, Check ALT 2 and ALT 2 CTRL CB If the caution indication persists: ALT 2 OFF
	BACKUP BATT	Back Up Batt <u>supply</u> failed, OR system voltage below 11 Volt	Check system voltage, if low consider <u>3.8.5 Alternator failure</u> / use of back-up battery

Light	Display	Condition	Implication/ Procedure
AMB. LOW FUEL Left	N/A	Usable fuel remaining less than 6 liter in left tank	This system is electrically independent of the fuel QTY indication. In case of conflicting information landing is advised as soon as practical
AMB. LOW FUEL Right	N/A	Usable fuel remaining less than 6 liter in right tank	This system is electrically independent of the fuel QTY indication. In case of conflicting information landing is advised as soon as practical
GRE., Fuel pump ON	N/A	El. Fuel pump is switched on	is triggered by the power supply to the electric pump – actual pump function of pressure built up must be checked using the fuel pressure indication
GRE., Land. light ON	N/A	Landing light or WIG/WAG is switched ON	is triggered by the landing light power supply in both, WIG/WAG and ON mode
GRE. Pitot Heat ON	N/A	Pitot Heat is switched ON	is triggered by the power supply to the heating element – it does not sense actual current or temperature built up. This must be checked in pre-flight inspection.
BLUE Ext. Power ON	N/A	External Power supply connected	is triggered by the connected external power Set park break / use wheel chocks Never taxi with the External power light illuminated

1.4 **Descriptive data**

- CS-23 Level 1 aircraft (formally CS-VLA)
- Day and Night VFR operation
- Maximum Take Off Weight 750kg
- Side-by-side seating
- Low wing monoplane
- Conventional cruciform design
- All aluminium airframe, composite canopy frames
- Power plant
 - o Engine Rotax 912 S3
 - Without airflow cap
 - BRM exhaust
 - BRM Airbox (carbon)
 - BRM Engine interface ring-mount
 - ROTAX oil cooler and tank – oil system without thermostat
 - ROTAX coolant radiator – coolant system with thermostat
 - o Propeller MTV-34-1-A/175-200
 - Hydraulic governor P-110-030/A
- Fuel system
 - o Fuel tanks in wing leading edge with strainer pick up
 - o Left/Right/OFF fuel selector
 - o Mechanical engine pump
 - o Electric fuel pump with check valve bypass
 - o Gascollator (water trap and filter)
 - o Fuel return line (left tank only)
 - o Fuel flow sensing
- Landing gear
 - o Fixed tricycle
 - o MLG composite spring type with differential hydraulic braking
 - o NLG welded steel design steered (two push/pull cable on excentre) and combined hydraulic/spring damper
- Control system
 - o Elevator and Aileron pushrod system
 - o Rudder cable / pulley system
 - o Electric actuated trim for pitch and roll
 - o Anti-Servo tab on pitch control
- Luggage
 - o Luggage compartments in cabin (15kg)
 - o Luggage compartments in wings (2 x 20kg each)
- AEPS
 - o BRS-6-1350 (ASTM compliant) on forward RHS fuselage

Document No.: ADXC-73-001-AFM	Non-approved page	Revision: A
	1-8	Date of Issue: 01.10.2020

- Electric system
 - o Battery: Varta YTX20L 18Ah Absorbent Glass Mat (AGM)
 - o 2 Alternators (combined about 60A or 800W capacity)
 - ALT 1 Internal ROTAX alternator
 - ALT 2 External Alternator
 - o External power (for engine start only)

1.4.1 Dimensions External

Total Length:.....	6.58	m
Maximum Height.....	2.36	m
Maximum Fuselage Width:	1.3	m
Wing span (incl. wing tip lights):.....	9.27	m
Wheel base	1.47	m
Wheel track.....	2.04	m
Maximum propeller diameter	1.75	m
Wing area (projected):	11.75	m ²
Wing mean aerodynamic chord (MAC)	1.343	m
Distance of M.A.C. L.E. to Datum (EX):	1.377	m

1.4.2 Dimensions Internal

Cabin height (floor to top canopy):.....	0.904	m
Cabin length (firewall to aft luggage compart.):.....	1.397	m
Cabin width (inside spacing canopy frame):	1.225	m
Luggage volume dimension wing locker (each side)		
36cm*41cm*21cm.....	31	litres
Luggage volume dimension fuselage.....		
52cm*17cm*96cm.....	85	litres

1.5 Three-view drawing

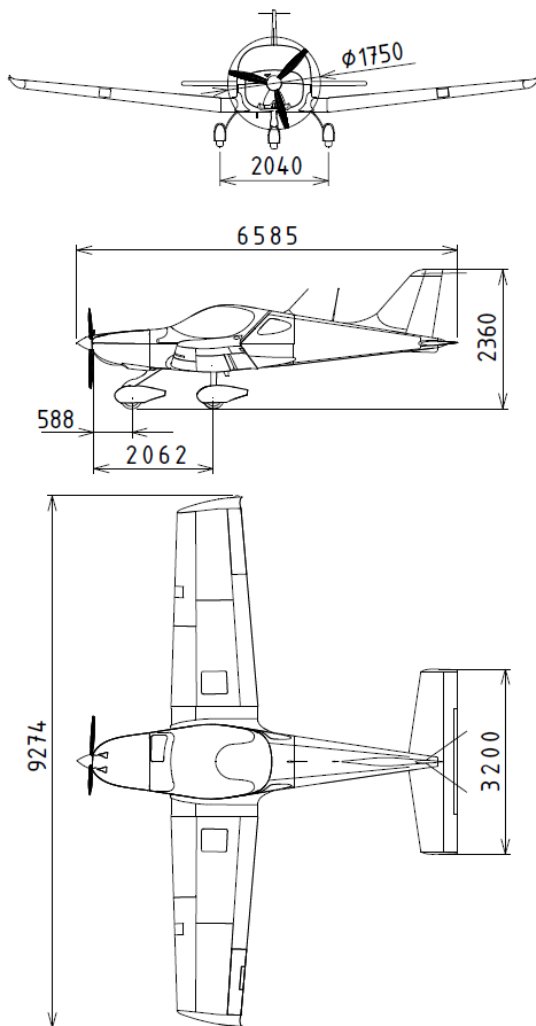

NOTE

Measures valid for static loaded condition, wing span incl. wing tip lights.

Document No.: ADXC-73-001-AFM	Non-approved page	Revision: A
	1-10	Date of Issue: 01.10.2020



AIRCRAFT FLIGHT MANUAL

BRISTELL B23

INTENTIONALLY LEFT BLANK

Document No.: ADXC-73-001-AFM	Non-approved page	Revision: A
	1-11	Date of Issue: 01.10.2020

SECTION 2

2 LIMITATIONS

2.1	<i>Introduction</i>	2-1
2.2	<i>Airspeed.....</i>	2-1
2.3	<i>Airspeed indicator markings</i>	2-2
2.4	<i>Powerplant.....</i>	2-3
2.5	<i>Powerplant instrument markings.....</i>	2-5
2.6	<i>Miscellaneous instrument markings</i>	2-6
2.7	<i>Weight</i>	2-6
2.8	<i>Centre of gravity.....</i>	2-7
2.9	<i>Approved manoeuvres</i>	2-8
2.10	<i>Manoeuvring load factors.....</i>	2-8
2.11	<i>Flight crew</i>	2-8
2.12	<i>Kinds of operation.....</i>	2-8
2.13	<i>Fuel.....</i>	2-9
2.14	<i>Maximum passenger seating</i>	2-9
2.15	<i>Other limitations.....</i>	2-9
2.16	<i>Placards</i>	2-10
2.17	<i>Minimum Equipment.....</i>	2-17

2.1 Introduction

Section 2 includes operating limitations, instrument markings, and basic placards necessary for safe operation of the aeroplane, its engine, standard systems and standard equipment.

The limitations included in this section and in Section 9 have been approved by European Union Aviation Safety Agency.

2.2 Airspeed

Speed		KEAS	KIAS	Remarks
V_{NE}	Never exceed speed	156	157	Do not exceed this speed in any operation.
V_{NO}	Max. structural cruising speed	135	136	Do not exceed this speed except in smooth air, and then only with caution.
V_A	Maneuvering speed	98	99	Do not make full or abrupt control movement above this speed, because under certain conditions the aircraft may be overstressed by full control movement.
V_{FE}	Maximum flap extended speed	81	82	Do not exceed this speed with flaps extended.

2.3 *Airspeed indicator markings*

Airspeed limitation color coding is programmed in the MFD/PFD displays

Marking	IAS value or range	Significance
	<i>knots</i>	
White	48-82	Positive Flap Operating Range. (Lower limit is maximum weight 1.1 VS0 in landing configuration. Upper limit is maximum speed permissible with flaps extended positive.)
Green	55-136	Normal Operating Range. (Lower limit is maximum weight 1.1 VS1 at most forward c.g. with flaps retracted. Upper limit is maximum structural cruising speed.)
Yellow	136-157	Maneuvers must be conducted with caution and only in smooth air.
Red line	157	Maximum speed for all operations.

2.4 Powerplant

Engine Manufacturer:		Bombardier-Rotax GMBH
Engine Model:		ROTAX 912S 3
Power	Max Take-off:	73.5 kW / 100 hp at 5800 rpm, max.5 min.
	Max. Continuous:	69 kW / 92.5 hp at 5500 rpm
Engine RPM	Max. Take-off:	5800 rpm, max. 5 min.
	Max. Continuous:	5500 rpm
	Idling:	Min. 1400 rpm
Coolant temperature (CT)	Minimum:	50 °C (122 °F)
	Maximum:	120 °C (248 °F) ethylen-glycol / water (50/50) mixture using "BASF Glysantin G48"; or other recommended brands. Refer to latest ROTAX service letter SI-912-016
	Optimum:	80 – 110 °C (176-230 °F)
Oil temperature	Minimum:	50 °C (12 °F)
	Maximum:	130 °C (266 °F)
	Optimum:	90 – 110 °C (190-230 °F)
Oil pressure:	Minimum:	0.8 bar (12 psi) - below 3500 rpm
	Maximum:	7 bar (102 psi) - cold engine start
	Optimum:	2 - 5 bar (29 – 73 psi) - above 3500 rpm
Fuel pressure	Minimum:	0.15 bar (2.2 psi)
	Maximum:	0.5 bar (7.26 psi) ¹
Exhaust gases temp.	Maximum:	880 °C (1616 °F)
Engine start, operating temperature	Maximum:	50 °C (120 °F) (ambient temperature)
	Minimum:	-25 °C (-13 °F) (Oil temperature)

¹ applicable for fuel pump from S/N 11.0036



AIRCRAFT FLIGHT MANUAL

BRISTELL B23

Propeller Manufacturer:		MT-Propeller Entwicklung GmbH
Propeller Model:		MTV-34-1-A/175-200
Diameter	Maximum:	175 cm
	Minimum:	-
Blade Angle (at 75% station)	Low:	+3 °
	High:	+55 °
Rotational speed restrictions	Max. Take Off Speed (propeller rpm)	2560 (equals 6220 engine RPM, engine is limiting)

Document No.: ADXC-73-001-AFM

Approved page

Revision: A

2-4

Date of Issue: 01.10.2020

2.5 Powerplant instrument markings

Powerplant limitation color coding is programmed in the MFD/PFD displays

Rotax 912	Minimum Limit (red line)	Caution Range (yellow)	Normal Operating Range (green)	Caution Range (yellow)	Maximum Range (red line)
Engine speed (RPM)		< 1400 ⁶ RPM	1400-5500 RPM	5500-5800 ³ RPM	5800 ¹ RPM
Oil Temp. (OT)		<50 °C ² 122 °F	50-110 °C 122-230 °F	110-130 °C ⁴ 230-266 °F	130 °C ¹ 266 °F
Exhaust Gas Temp. (EGT)	-	-	<880 °C <1616°F	-	880°C ¹ 1616 °F
Cylinder Head Coolant Temp (CHT)	-	-	<120°C <230°F	-	120 °C ¹ 248 °F
Oil Pressure (OP)	0.8 bar ¹ 12 psi	0.8-2 bar ⁴ 12-29 psi	2-5 bar 29-73 psi	5-7 bar ⁴ 73-102 psi	7 bar ¹ 102 psi cold engine starting
Fuel Pressure (FP)	0.15 bar ^{1,5} 2.2 psi	-	0.15-0.5bar 2.2 – 7.26psi	-	0.5 bar ¹ 7.26 psi
Manifold Pressure (MP)	-	-	0-27inHg	27-31inHg ³	31inHg ¹

¹ this event triggers the red “master warning” light and appears on PDF/MFD text message.

² this event triggers the yellow “master caution” light and appears on PDF/MFD text message.

³ operation above maximum continuous power for maximum 5min, see chapter 7.9.1 for details of permissible RPM/manifold pressure combinations.

⁴ this range in “non-optimum” and does not trigger a amber “master caution”.

⁵ transient fuel pressure below 0.15bar acceptable for maximum 5sec.

⁶ engine ground idle lower speed limit.

Document No.: ADXC-73-001-AFM	Approved page	Revision: A
	2-5	Date of Issue: 01.10.2020

2.6 *Miscellaneous instrument markings*

MFD/PFD displays are programmed with limitation color coding for:

	Minimum Limit (red line)	Caution Range (yellow)	Normal Operating Range (green)	Caution Range (yellow)	Maximum Limit (red line)
Electric system voltage	8 to 11 ^{*1} Volt	11 to 12 ^{*2} Volt	12 to 15 Volt	-	15 to 16 ^{*1} Volt
Battery current	-25 ^{*1} Ampere	-25 to -10 ^{*2} Ampere	-10 to +10 Ampere	+20 to +30 ^{*2} Ampere	+30 ^{*1} Ampere
Fuel quantity ^{*3}	1liter ^{*1} (unusable fuel mark)	1 to 10 ^{*2} litres	10 to 45 litres		
Fuel flow	-	-	0 to 35 litres/hour	35 to 40 litres/hour	-

^{*1} this event triggers the red “master warning” light and appears on PDF/MFD text message.

^{*2} this event triggers the amber “master caution” light and appears on PDF/MFD text message.

^{*3} a separate and independent amber “low fuel caution light” is triggered with the remaining usable fuel quantity being 6liter on the respective tank.

2.7 *Weight*

Max. Take-off weight..... 750 kg

Max. Landing weight..... 750 kg

Max. Zero Wing load weight² 660 kg

Weight of fuel (120 l)..... 87 kg

Max. baggage behind seats

lower area..... 15 kg

upper area 1 kg

Max. Wing locker loading (per side)..... 20 kg

² Maximum mass when wing tanks and wing lockers are empty

Document No.: ADXC-73-001-AFM	Approved page	Revision: A
	2-6	Date of Issue: 01.10.2020

Maximum lateral asymmetry (fuel+wing locker baggage) .. 15 kg
 Minimum crew weight 55 kg
 Maximum crew weight see 6.4

NOTE
 Actual empty weight is shown in SECTION 6.

2.8 Centre of gravity

Operating C.G. range.....25% to 34.5% of MAC
 Maximum weight at 25%..... 600 kg
 Most forward C.G. at MTOW 750kg.....31% of MAC
 Maximum weight at aft C.G. 34.5%..... 750 kg
 Maximum aft C.G. at minimum take-off weight 490kg.....32% of MAC
 MAC..... 1.343 m
 MAC Leading edge 1.377 m
 Datum: Propeller flange on the engine.

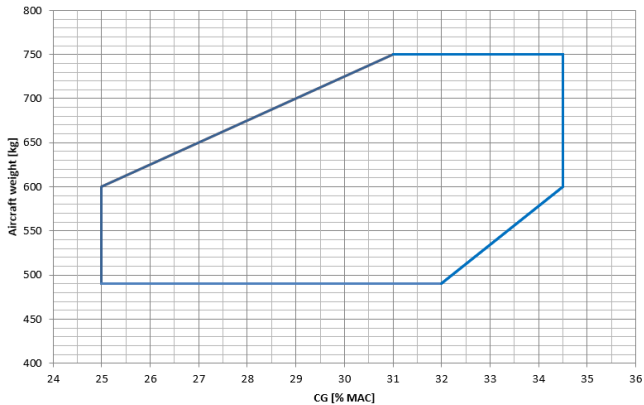

2.9 **Approved manoeuvres**

EASA category: CS23 Amdt 5 Level 1 (AMC3 CS-VLA),

1. All standard maneuvers during normal flight
2. Stalls (except whip stalls)
3. Non-aerobatic maneuvers:
4. Lazy eight
5. Chandelle
6. Steep turn in which the angle of bank is not more than 60°

WARNING

Aerobatics and intentional spins are prohibited

2.10 **Manoeuvring load factors**

Maximum positive limit load factor

Flaps UP+4 g

Flaps - any other position.....+ 2 g

Maximum negative limit load factor

Flaps UP-2 g

Flaps - any other position.....0 g

2.11 **Flight crew**

Number of seats..... 2

Minimum crew..... 1 pilot on the left seat

2.12 **Kinds of operation**

Day-VFR

Night-VFR

WARNING

Flight into expected or actual icing conditions is prohibited.

Minimum required equipment for either operating mode is defined in Chapter 6.6.

Document No.: ADXC-73-001-AFM	Approved page	Revision: A
	2-8	Date of Issue: 01.10.2020

2.13 **Fuel**

Tank capacity..... 60 l in each fuel tank

Total fuel.....2 x 60 l = 120 l

Usable fuel..... 2 x 59 = 118 l

Unusable fuel.....2 x 1l = 2 l

Approved fuel grades:

- EN 228 Super and Super Plus (RON 95)
- AVGAS 100LL (ASTM D910)³

2.14 **Maximum passenger seating**

Maximum passenger seating 1

2.15 **Other limitations**

Maximum certified altitude 14.000 ft

Outside air temperature OAT (range)⁴ ISA +/-20 K resulting in

Max OAT at SL 15 °C+20 K = 35 °C

Min OAT at 14.000ft -12.7 °C-20 K = -32.7 °C

Autopilot engagement during take-off, initial climb, final approach and landing is PROHIBITED.

Any autopilot mods related to take off, approach, landing and performance-based NAV mods is not certified in this aircraft.

Smoking prohibited.

AEPS activation speed maximum.....157 KIAS

³ Not recommended for prolonged usage by the engine manufacturer.

⁴ Compliance with engine cooling provisions are demonstrated.





Document No.: ADXC-73-001-AFM	Approved page	Revision: A
	2-9	Date of Issue: 01.10.2020

2.16 Placards







Limitation Placard:

Placard	Meaning and location
<p style="text-align: center;">This aeroplane is classified as a very light aeroplane approved for Day- and Night-VFR operation, in non-icing conditions. All aerobatic manoeuvres including intentional spinning are prohibited. See Flight Manual for other limitations.</p>	<p>On the instrument panel left-hand side above MFD</p>
<p style="text-align: center;">AIRSPEED LIMITATIONS:</p> <p style="text-align: center;">V_{NE} 157 KIAS V_A 99 KIAS V_{FE} 82 KIAS V_{S0} 44 KIAS</p>	<p>On the instrument panel left-hand side above MFD.</p>

Other Placards:

Placard	Meaning and location
<p>Instrument panel left to right:</p> 	<p>Above Choke handle on left side of instrument panel</p>
	<p>On back-up battery switch cap</p>
	<p>Master switch arrangement lower left panel</p>
	<p>Pilot side electric controls lower left panel</p>
	<p>Carb heat control knob lower left panel</p>



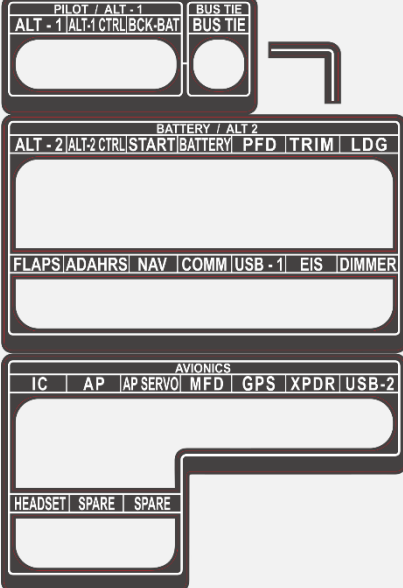



Document No.: ADXC-73-001-AFM	Approved page	Revision: A
	2-10	Date of Issue: 01.10.2020

Placard	Meaning and location
	Call sign label (example) above PFD screen
	Above dimmer and indication lights centre panel
	On centre panel next to trim indication
	Heat direction control knob lower right panel
	Heat control knob lower right panel
	Park brake knob lower right panel
	Right side circuit breaker area





Placard	Meaning and location																																										
<table border="1" style="margin: auto; border-collapse: collapse;"> <tr> <td colspan="7" style="text-align: center;">Calibrated with radio ON, Engine running</td> </tr> <tr> <td style="text-align: center;">For</td> <td style="text-align: center;">N</td> <td style="text-align: center;">30</td> <td style="text-align: center;">60</td> <td style="text-align: center;">E</td> <td style="text-align: center;">120</td> <td style="text-align: center;">150</td> </tr> <tr> <td style="text-align: center;"><i>Steer</i></td> <td></td> <td></td> <td></td> <td></td> <td></td> <td></td> </tr> <tr> <td style="text-align: center;">For</td> <td style="text-align: center;">S</td> <td style="text-align: center;">210</td> <td style="text-align: center;">240</td> <td style="text-align: center;">W</td> <td style="text-align: center;">300</td> <td style="text-align: center;">330</td> </tr> <tr> <td style="text-align: center;"><i>Steer</i></td> <td></td> <td></td> <td></td> <td></td> <td></td> <td></td> </tr> <tr> <td colspan="7">DATE:</td> </tr> </table>	Calibrated with radio ON, Engine running							For	N	30	60	E	120	150	<i>Steer</i>							For	S	210	240	W	300	330	<i>Steer</i>							DATE:							<p>Compass deviation placard (for optional magnetic compass on top of glareshield)</p>
Calibrated with radio ON, Engine running																																											
For	N	30	60	E	120	150																																					
<i>Steer</i>																																											
For	S	210	240	W	300	330																																					
<i>Steer</i>																																											
DATE:																																											
Cabin and Center console front to aft:																																											
	Left fuselage side panel, below canopy frame																																										
	Right fuselage side panel, below canopy frame																																										
	At internal canopy locking handle																																										
	Above AEPS Handle																																										
	On AEPS Handle																																										
	Below AEPS handle																																										
	AEPS locking pin																																										
	On right side of Throttle quadrant																																										
	On left side of Throttle quadrant																																										
	Next to fuel selector																																										

Placard	Meaning and location
	On left and right side of centre console
	Headset / Headset power
	USB outlets between seats
	On the wall of the lower fuselage luggage compartment
	Between pilot seat to indicate the ELT location which is on a bracket inside the fuselage below the luggage compartment.
Fuselage exterior	
	Nose gear wheel cover
	Left and right main gear wheel cover
	On oil hatch outside and on oil tank

Document No.: ADXC-73-001-AFM	Approved page	Revision: A
	2-13	Date of Issue: 01.10.2020

Placard	Meaning and location
	On lower left side of lower cowling
Conv. ethylene-glycol 50% water dilution, 2.5L, refer to Rotax SI-912-016	On coolant reservoir
	On firewall, right top engine side above brake fluid reservoir
	On AEPS Egress panel on right side of fuselage in front canopy. It indicates the location of the rocket.
	On both sides of the aircraft behind the canopy and in front of the rear windows
	At canopy lock outside right
	

Placard		Meaning and location								
		At canopy lock outside left								
		Left and right static port on fuselage side wall								
<table border="1"> <thead> <tr> <th>IDENTIFICATION PLATE</th> </tr> </thead> <tbody> <tr> <td>Registration mark:</td> </tr> <tr> <td>Manufacturer's name:</td> </tr> <tr> <td>Type / model:</td> </tr> <tr> <td>Serial Number:</td> </tr> <tr> <td>Type Certificate No.:</td> </tr> <tr> <td>Empty weight:</td> </tr> <tr> <td>MTOW :</td> </tr> </tbody> </table>	IDENTIFICATION PLATE	Registration mark:	Manufacturer's name:	Type / model:	Serial Number:	Type Certificate No.:	Empty weight:	MTOW :		Aircraft identification plate (might vary with nationality of registration), mounted on the rear fuselage, beneath the horizontal stabiliser
IDENTIFICATION PLATE										
Registration mark:										
Manufacturer's name:										
Type / model:										
Serial Number:										
Type Certificate No.:										
Empty weight:										
MTOW :										
Wings and stabilizers										
		Wing locker placard (for lock)								

Placard	Meaning and location
	<p>Around fuel tank filler caps on both wings.</p>
	<p>On the trailing edge of flaps, ailerons, trim tab and rudder to avoid excessive pressure on them.</p>
	<p>Wing flap root areas</p>
Marking at elevator trim indicator	
	<p>Marking for the optimal elevator trim tab position for take-off positioned next to the fourth LED from the top</p>

2.17 *Minimum Equipment*

A.) The following equipment must be in operating conditions for the respective operation modes

Item/Equipment	VFR-Day	VFR-Night
Emergency exit hammer	X	X
Landing light		X
Anti-Collision light	X	X
Position light	during twilight	X
L3 ESI-500 with Magnetometer ⁵	X	X
Pitot heat		X
Transponder	⁶	X
Com-Radio	⁶	X
Day/Night switch, Dimming functions, glareshield light		X
Alternators	MIN ONE	Both
Back-Up Battery		X

B.) Acceptable inoperative equipment is

- AEPS (must be marked "Inoperative")
- Cabin heat in fully CLOSED position
- Autopilot
- Intercom
- USB-power outlets⁷
- External power

C.) Optional Equipment is

- Magnetic compass
- Autopilot

All other functions and equipment not listed above in A.), B.) or C.) must be operational at all times.

⁵ An inoperative magnetometer can be mitigated by a functioning magnetic compass (optional, if installed)

⁶ As required by ATC

⁷ The USB power outlets are intended for PED's. The pilot is responsible for the compatibility of the PED with the aircraft on-board systems.

SECTION 3

3 EMERGENCY PROCEDURES

3.1	<i>Introduction</i>	3-2
3.2	<i>Engine failure</i>	3-2
3.2.1	Engine failure during take-off run	3-2
3.2.2	Engine failure enroute or during take-off	3-2
3.2.3	Carburettor icing	3-3
3.3	<i>Air start</i>	3-3
3.4	<i>Smoke and fire</i>	3-4
3.4.1	Engine fire on ground at engine starting	3-4
3.4.2	Fire on ground with engine running.....	3-4
3.4.3	Engine fire during take-off	3-4
3.4.4	Engine fire in flight	3-5
3.4.5	Fire in the cockpit.....	3-6
3.5	<i>Glide</i>	3-7
3.6	<i>Emergency landing</i>	3-8
3.6.1	Landing without engine power	3-8
3.6.2	Precautionary landing / land as soon as practical	3-8
3.6.3	Landing with a flat tire	3-9
3.6.4	Landing with a defective landing gear.	3-9
3.6.5	Aircraft turn over	3-9
3.7	<i>Recovery from unusual attitudes</i>	3-10
3.7.1	Loss of spatial orientation	3-10
3.7.2	Recovery from unintentional spin	3-10
3.8	<i>Other emergencies</i>	3-11
3.8.1	Vibration	3-11
3.8.2	Autopilot malfunction	3-11
3.8.3	Loss of oil pressure.....	3-11

Document No.: ADXC-73-001-AFM	Approved page	Revision: A
	3-0	Date of Issue: 01.10.2020

3.8.4	High oil pressure.....	3-11
3.8.5	Alternator failure / use of back-up battery.....	3-12
3.8.6	Bus system failure	3-13
3.8.7	Overvoltage	3-13
3.8.8	Inadvertent icing encounter.....	3-13
3.8.9	Loss of primary instruments.....	3-14
3.8.10	RPM overspeed/underspeed/fluctuations; Propeller vibration	3-14
3.9	<i>AEPS activation</i>	3-14

3.1 *Introduction*

Section 3 provides checklists and detail procedures for coping with various emergencies that may occur.

In case of emergency the process steps described in this section should be followed and applied as necessary to correct the problem.

Most failure conditions are associated with caution and warning lights. In the following table a general overview is given:

3.2 *Engine failure*

3.2.1 Engine failure during take-off run

1. Throttle - reduce to idle
2. Ignition - switch off
3. Apply brakes

3.2.2 Engine failure enroute or during take-off

1. Speed - gliding at 67 KIAS
2. Altitude below 150ft AGL - land in take-off direction
over 150 ft AGL: - choose a landing area with little deviation from current direction
over 1000ft AGL: - consider procedure turn for landing on runway
enroute: - consider engine restart attempt see section 3.3

WARNING

Returning to the runway with less than 1000ft AGL statistically is the main reason for stall/spin entries and considered the "impossible turn"

3. Wind - find direction and velocity
4. Landing area - choose free area without obstacles
5. Flaps - extend as needed
6. Fuel Pump - OFF
7. Fuel Selector - shut off
8. Ignition - switch off
9. Safety harness - tighten

Document No.: ADXC-73-001-AFM	Approved page	Revision: A
	3-2	Date of Issue: 01.10.2020

10. Master switch - OFF for VFR DAY
ON for VFR NIGHT

WARNING

After switching Master switch OFF, control of the flaps is no longer possible

11. Landing Lights - ON for VFR NIGHT
12. Land

3.2.3 Carburettor icing

Carburetor icing results in a decrease in engine power and an increase of engine temperatures.

To recover the engine power, the following procedure is recommended:

1. Carburetor heat - PULL
2. If possible, - leave icing area
3. After 1-2 minutes - Check the engine power gradually up to cruise conditions

If you fail to recover the engine power, land as soon as practical, if needed refer to 3.6 Emergency landing.

NOTE

Your aircraft is equipped with carburetor heating, use it for extended period of descent and also in area of possible carburetor icing. Periodic checks in conditions of visible moisture are recommended. Remember: Aircraft is approved to operate in VMC condition only!

3.3 ***Air start***

1. Electric pump - ON
2. Fuel Selector - switch to fullest fuel tank
3. Speed - 75 KIAS
4. Ignition - check on
5. Starter(if needed) - engage

NOTE

With ignition off the propeller does not stop rotation in the air even at speeds close to stall. A stopped propeller is a clear sign of a damaged engine

Document No.: ADXC-73-001-AFM	Approved page	Revision: A
	3-3	Date of Issue: 01.10.2020

3.4 Smoke and fire

3.4.1 Engine fire on ground at engine starting

1. Starter - keep in starting position
2. Brakes - apply
3. Fuel Selector - close
4. Throttle - full power
5. Heating - close
6. Ignition - switch off after the fuel in carburetors is consumed and engine shut down
7. Master - OFF
8. Leave the airplane
9. Fire extinguisher (if installed) - use as appropriate
10. Call for a fire-brigade if you cannot extinguish the fire.

3.4.2 Fire on ground with engine running

1. Heating - close
2. Brakes - apply
3. Fuel selector - close
4. Throttle - full power
5. Ignition - switch off after the fuel in carburetors is consumed and engine shut down
6. Master - OFF
7. Leave the airplane
8. Fire extinguisher (if installed) - use as appropriate

NOTE

The designated place for fire extinguisher installation is located in front of the main spar at the front end of the pilot seat in easy reach of the pilot

9. Call for a fire-brigade if you cannot extinguish the fire.

3.4.3 Engine fire during take-off

1. Speed - 65 KIAS
2. Heating - close

Document No.: ADXC-73-001-AFM	Approved page	Revision: A
	3-4	Date of Issue: 01.10.2020

If landing is ensured OR fire gets critical:

3. Fuel Selector - close
4. Throttle - full power
5. Ignition - switch off after the fuel in carburetors is consumed and engine shut down
6. Master - OFF
7. Land and stop the airplane
8. Leave the airplane
9. Fire extinguisher - use as appropriate
10. Call for a fire-brigade if you cannot extinguish the fire.

3.4.4 Engine fire in flight

1. Heating - close
2. Fuel Selector - close
3. Throttle - full power
4. Ignition - switch off after the fuel in carburetors is consumed and engine shut down
5. Emergency landing - perform according to 3.6.1
6. Leave the airplane
7. Fire extinguisher (if installed) - use as appropriate
8. Call for a fire-brigade.

NOTE

Time from fuel valve closing to engine stop is about 30 seconds!

WARNING

Do not attempt to re-start the engine!

Document No.: ADXC-73-001-AFM	Approved page	Revision: A
	3-5	Date of Issue: 01.10.2020

3.4.5 Fire in the cockpit

- | | |
|-------------------------------------|-----------------------------|
| 1. Master switch | - switch off |
| 2. Heating | - close |
| 3. Fire extinguisher (if installed) | - use as appropriate |
| 4. If fire can be stopped: | - Land as soon as practical |
| If not: | - Land as soon as possible |

NOTE:

In case of extreme smoke and inability to evacuate by fresh air vents an in flight un-locking of the canopy can be considered. Un-locking at speeds below V_F without side-slip is demonstrated to lift the canopy rear frame by a few centimeters enabling continued safe flight and landing. This is not flight tested for the full airplane envelope.

Document No.: ADXC-73-001-AFM	Approved page	Revision: A
	3-6	Date of Issue: 01.10.2020

3.5 *Glide*

- 1. Speed - 67 KIAS
- 2. Flaps - retracted

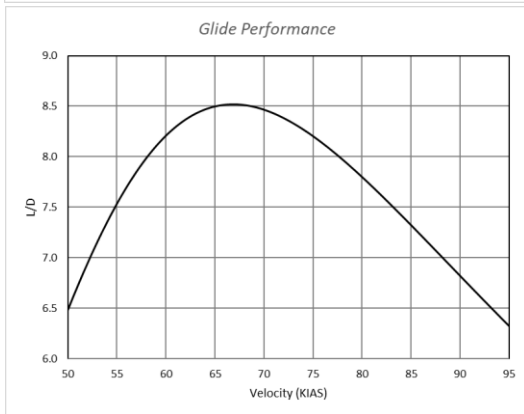
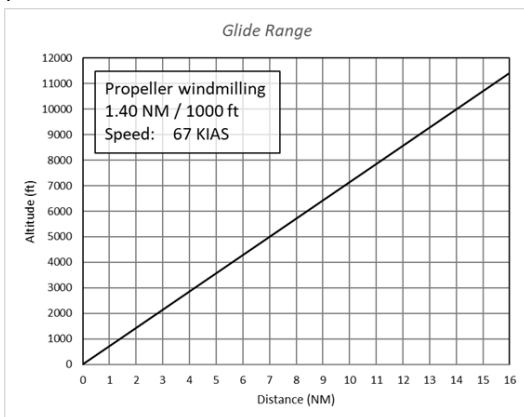

CAUTION

Engine rotation with ignition off does not stop with airspeed even at stall. However an inflight engine failure or propeller control failure could lead to such condition which is not tested. A further degradation of glide performance in such condition should be anticipated

3.6 **Emergency landing**

3.6.1 Landing without engine power

Emergency landings might be required in the case of engine failure and the engine cannot be re-started.

1. Speed - adjust for optimum gliding 67 KIAS
2. Propeller - Take-off position
3. Trim - adjust
4. Safety harness - tighten
5. Landing light - ON
6. Flaps - extend as needed

Depending on expected landing quality:

7. COM - Make distress call (MAYDAY)
8. XPDR - 7700
9. Fuel Selector - close
10. Ignition - switch off

11. Shallow turns only

Before touch down

12. Master switch - OFF for VFR DAY
- ON for VFR NIGHT

WARNING

After switching Master switch OFF, control of the flaps is no longer possible

13. Landing Lights - ON for VFR NIGHT

3.6.2 Precautionary landing / land as soon as practical

A precautionary landing might be required in the cases where the pilot may be disorientated, the aircraft has no fuel reserve or possibly in bad weather conditions.

1. Speed - 67 KIAS
2. Propeller - Take-off position
3. Trim - adjust
4. Choose landing area, determine wind direction
5. COM - Report landing location

Document No.: ADXC-73-001-AFM	Approved page	Revision: A
	3-8	Date of Issue: 01.10.2020

6. Perform low-altitude passage into wind over the right-hand side of the chosen area with flaps extended 10° and thoroughly inspect the landing area for obstacles.
7. Perform circuit pattern.
8. Perform approach
9. Flaps - extend as needed
10. Power - idle (for touch-down)
11. After stopping the airplane switch off all switches, shut off the fuel selector, lock the airplane and seek for assistance.

NOTE

Watch the chosen area steadily during precautionary landing.

3.6.3 Landing with a flat tire

1. During landing keep the damaged wheel above ground as long as possible using the aileron or elevator control, as applicable
2. Maintain the direction on the landing roll out, applying rudder control.

3.6.4 Landing with a defective landing gear.

1. If the main landing gear is damaged, perform touch-down at the lowest practicable speed and if possible, maintain direction during landing run.
2. If the nose wheel is damaged perform touch-down at the lowest practicable speed and hold the nose wheel above the ground by means of the elevator control as long as possible.

3.6.5 Aircraft turn over

In inverted situation, following a crash or soft ground loop, it is essential to leave the airplane as soon as possible to mitigate the risk of fuel leak post-crash fire.

In most cases of turn-over the transparency shatters. If this is not the case an emergency hammer is provided which is stored inside of the glovebox between the occupant seat. Appreciable force is required to provide sufficient opening for egress.

Depending on the situation the pilot should consider to keep the seat belt closed until actual egress is performed to remain suspended for the required work.

Document No.: ADXC-73-001-AFM	Approved page	Revision: A
	3-9	Date of Issue: 01.10.2020

3.7 Recovery from unusual attitudes

3.7.1 Loss of spatial orientation

If spatial orientation is lost or manual control of the airplane is no longer possible: Press „LVL“ button on the Autopilot! The autopilot will take over control and put the airplane in a level attitude.

If control is not regained consider activation of the AEPS system.

3.7.2 Recovery from unintentional spin

WARNING

Intentional spins are prohibited!

There is no uncontrollable tendency of the airplane to enter into a spin provided the normal piloting techniques are used.

Caution

The airplane is demonstrated to feature acceptable and benign departure characteristics. The following spin recovery technique has not been flight tested but is defined based on best available engineering judgement

If an unintentional spin is encountered, then using the standard “PARE” recovery technique is advised:

- | | |
|----------------------------|--|
| 1. Power | - idle |
| 2. Aileron control | - ailerons neutralized |
| 3. Rudder pedals | - full opposite rudder
(to the mechanical stop) |
| 4. Elevator control | - push forward until rotation stops |

When rotation stops:

- | | |
|------------------|---------------------------------|
| 5. Rudder pedals | - neutralize rudder immediately |
| 6. Recover | - gently pull out from the dive |

Document No.: ADXC-73-001-AFM	Approved page	Revision: A
	3-10	Date of Issue: 01.10.2020

3.8 Other emergencies

3.8.1 Vibration

If any forced aircraft vibrations appear, it is necessary:

1. To set engine speed to such power rating where the vibrations are lowest. In case of severe vibrations, with identified origin being the powerplant and endangering structural integrity the engine should be shut down.
2. To land as soon as practical or to perform an emergency landing according to 3.6

3.8.2 Autopilot malfunction

In the case of an autopilot malfunction,

1. AP OFF button (stick) - press
2. Autopilot - circuit breaker off

WARNING

Take-off, initial climb, final approach and landing with AP engaged and any operation with malfunctioning AP are PROHIBITED.

NOTE

AP should be powered at all times during flight to support the envelope protection and LVL recovery function

3.8.3 Loss of oil pressure

1. Reduce engine power setting to the minimum necessary
2. Check oil temperature
if high: - continue flight on low power setting and potential descent for improved cooling

if temperature is normal or
if temperature decrease does not result in improvement:
- land as soon as practical

3.8.4 High oil pressure

1. Reduce engine power setting to the minimum necessary
2. engine RPM (propeller) - reduce <5000

Document No.: ADXC-73-001-AFM	Approved page	Revision: A
	3-11	Date of Issue: 01.10.2020

3. Speed - 67 KIAS
4. Land as soon as practical 3.6.2.

3.8.5 Alternator failure / use of back-up battery

The Rotax 912 S engine has an integrated AC generator, a further external alternator is installed. Alternator failure is indicated on the PFD. Voltage drop below 11 volts is indicated by "Low Volt" warning on EFIS display and EMS caution light on instrument panel.

If both alternator fail an additional back up battery can be activated supplying

- the Garmin PFD / ADAHRS / EIS
- Glareshield lights

for a limited period of time (around 30 minutes).

The L3 ESI-500 instrument is additionally equipped with an internal backup battery.

In any case switch off all non-essential electrical equipment and land as soon as practical.

Use of back-up battery:

1. Back up battery switch - engage
2. Back up battery CB - pull
3. EIS CB - pull
4. PFD CB - pull
5. ADAHRS CB - pull
6. DIMMER CB - pull
7. L3 switch - off
8. L3 - confirm activation of internal battery
9. USB power - remove load

NOTE

Functionality of low fuel warning and indication light dimming is no longer given

Document No.: ADXC-73-001-AFM	Approved page	Revision: A
	3-12	Date of Issue: 01.10.2020

3.8.6 Bus system failure

The B23 electric bus system features two main sections Pilot/ALT1 (with the Avionic Sub-Bus) and Batt/ALT 2. They are connected via the BUS-TIE circuit breaker

Both sides of the system provide a set of functions enabling safe flight and landing. See table in Section 7.11 Electrical system.

Upon complete loss of electric power

1. Back up switch - engage
2. Master switch - OFF
3. Alt1 switch - OFF
4. Alt2 switch - OFF
5. BUS TIE CB - PULL
6. BATT CB - PULL
7. ALT1 CB - PULL
8. ALT2 CB - PULL

Individually check BATT/ALT1/ALT2 by setting the respective CB and associated control in operational mode to locate the malfunction.

Continue flight on the reminder of electric power sources

Land as soon as practical.

3.8.7 Overvoltage

Overvoltage more than 15 Volts

1. Reduce engine RPM (propeller and power)
2. Alternators - Check ALT-1 and ALT-2 to identify which alternator causes the problem. Keep that one off for the reminder of the flight
3. If positive charge (Amps) cannot be maintained on one alternator:
Consider use of back-up battery see 3.8.5
- Land as soon as practical.

3.8.8 Inadvertent icing encounter

WARNING

Operation under known icing conditions is PROHIBITED!

1. Pitot heat - ON

Document No.: ADXC-73-001-AFM	Approved page	Revision: A
	3-13	Date of Issue: 01.10.2020

2. Exit icing conditions - change altitude or turn back.
3. Carb heat - pull knob to ON
4. Cockpit heating - pull knob to ON
5. Up/Down knob - pushed forward (UP) to defrost windshield

3.8.9 Loss of primary instruments

Although the Garmin displays might be used as main electronic flight instrument, the independent L3 ESI-500 is the primary flight display. In case the Garmin displays have a malfunction (or loss of function) or in case of discrepancy refer to L3 ESI-500.

The Garmin autopilot is independent of the Garmin display, however in case of loss of Garmin display function use the autopilot with caution and monitor your flight path carefully!

3.8.10 RPM overspeed/underspeed/fluctuations; Propeller vibration

The propeller control by the hydraulic governor is dependent on the oil-circuit as well as a chain of mechanical connections.

In any case of erroneous behaviour:

1. Throttle and RPM control: - adjust for smooth running
2. If engine operates within limit: - land as soon as practical
If not: - land as soon as possible

3.9 **AEPS activation**

The airplane is equipped with an airplane emergency parachute system (AEPS).

Its use should be considered as last resort for situations of

- loss of control,
- loss of structural integrity or
- loss of spatial orientation as well as
- inability to land safely.

The use of the rescue system will likely result in heavy damage to the aircraft and injuries to the aircraft occupants.

WARNING

The rescue system must be unlocked during flight to allow immediate use in emergency!

Document No.: ADXC-73-001-AFM	Approved page	Revision: A
	3-14	Date of Issue: 01.10.2020

WARNING

Avoid activation in strong updrafts. In these situations, it is best to first get away from the updraft, and then to activate the rescue system.

WARNING

Minimum effective altitude for the use of AEPS is 1000ft (300 m) above ground. By activating at height under 1000 ft the swinging oscillation of the aircraft may not stabilize and the crew may be injured by impact with terrain. Additionally, the parachute canopy may not be fully loaded so as to properly reduce the speed of fall.

If time is not critical:

1. Report your emergency and intention to use the AEPS.
2. Advise your passenger to follow your orders and actions.
3. Tighten seat belts.
4. Activate ELT
5. Check area beneath to avoid power lines and similar risks.
6. Switch off fuel supply
7. Cut power, reduce speed as much as possible.
8. Switch off main switch
9. Pull the activation handle strongly.
10. Protect your face with your hands, put your hands and feet together (i.e. „roll into a ball“, firm up your whole body!
11. Firm up your body before landing and impact!
12. After landing promptly leave the aircraft, if possible, in opposite direction of the wind.

In a time critical situation:

- activate the AEPS immediately, regardless of the flight altitude, attitude and terrain over which you are
- Follow all other steps of procedure above.

Document No.: ADXC-73-001-AFM	Approved page	Revision: A
	3-15	Date of Issue: 01.10.2020

SECTION 4

4 NORMAL PROCEDURES

4.1	<i>Introduction</i>	4-1
4.2	<i>Daily inspection</i>	4-1
4.3	<i>Preflight inspection</i>	4-2
4.4	<i>Normal procedures and check list</i>	4-6
4.4.1	Before engine starting.....	4-6
4.4.2	Use of external power	4-6
4.4.3	Engine starting.....	4-6
4.4.4	Before Taxiing	4-8
4.4.5	Taxiing.....	4-8
4.4.6	Before take-off / Engine run up:	4-9
4.4.7	Take-off	4-10
4.4.8	Short and Soft field take-off:.....	4-11
4.4.9	Climb	4-11
4.4.10	Cruise	4-12
4.4.11	Descent	4-13
4.4.12	Before landing	4-13
4.4.13	Balked landing (Go around)	4-14
4.4.14	Landing.....	4-14
4.4.15	After landing	4-14
4.4.16	Shutdown.....	4-15
4.4.17	Flight in rain	4-16

4.1 Introduction

Section 4 provides checklist and amplified procedures for the conduct of normal operation. Normal procedures associated with optional systems can be found in Section 9.

4.2 Daily inspection

Daily inspection is to be performed prior to the first flight of the day. It consists of actions identifying any issues that may have accumulated during the time the airplane has been parked, actions to remove any storage/mooring equipment, as well as actions requiring removal of the cowling.

①	<p>General inspection outside</p> <ul style="list-style-type: none"> - Inspect general condition of aircraft - Inspect for any birds or insects nesting in any of the cowling openings or other areas - Inspect for leaks - Inspect for water entering where it should not - Check tire pressure (2.1bar main gear, 1.8bar nose gear) - Remove any pitot/static port protections - Remove any mooring / tie down ropes - Remove wheel chocks, check freedom of wheel rotation with park brake is OFF
②	<p>Remove UPPER cowling</p> <ul style="list-style-type: none"> - Inspect condition of fuel hoses - Inspect condition of oil hoses - Inspect attachment of spark plug connectors - Inspect tightness of exhaust mounting - Inspect exhaust mounting springs - Inspect air hose routing, tightness of connection - Inspect exhaust and exhaust heat shroud condition - Fuel system draining, wings and gascollator - Check oil level <div style="border: 1px dashed black; padding: 10px; margin-top: 10px;"> <p style="text-align: center;">NOTE</p> <p>Oil level check requires to open the oil access hatch and remove the oil filler cap. Then the engine is manually rotated slowly in the normal direction of rotation until a gurgling sound is heard. Only then the dip stick correctly indicates the amount of oil.</p> </div>

	<ul style="list-style-type: none"> - Check coolant level - Check brake fluid level - Check battery pole condition - Check Bowden cable condition and attachment - Inspect inside of cowling for signs of exhaust gas impingement, excessive heat, chaffing - Inspect cowling attachments <p>Re-install cowling</p> <ul style="list-style-type: none"> - Inspect all cowling fasteners being tight
③	<p>Cockpit checks</p> <ul style="list-style-type: none"> - Inspect general condition - Remove control locks, if applicable - Inspect area below and aft of seats for foreign objects

4.3 ***Preflight inspection***

Carefully carry out the pre-flight inspection following the instructions in the inspection list below. Incomplete or careless inspection can cause an accident.

NOTE

The word "condition" in the instructions means a visual inspection of surface for damage deformations, scratching, chafing, corrosion or other damages, which may lead to flight safety degradation.

The manufacturer recommends carrying out the pre-flight inspection as follows:

Document No.: ADXC-73-001-AFM	Non-approved page	Revision: A
	4-2	Date of Issue: 01.10.2020

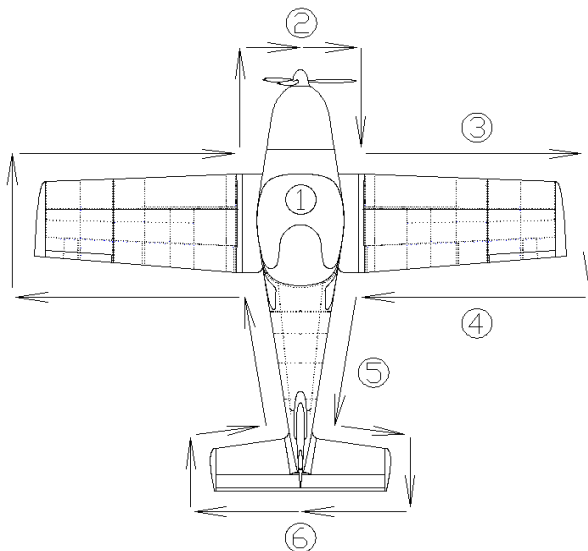

①	<ul style="list-style-type: none"> - Ignition - Avionics/Instruments - Cockpit - Loading securing - Master switch - Avionics switch - Fuel quantity indication - Flap - Lights - Pitot tube heating - Avionics switch - Master switch - Control system - Rudder pedals - Canopy 	<ul style="list-style-type: none"> - OFF - Check condition - Check for loose objects and condition - Check for weight and balance, - ON - ON - Check - Check operation - Select down (for inspection) - check as needed for the flight - for day-operation set DIMMERS to left - check function (visible by current consumption and notable by warm up. Caution: HOT surface) - OFF - OFF - visual inspection, function, clearance, free movement up to stops - set for flight condition according pilot size - condition of attachment, cleanness
---	--	---

②	<ul style="list-style-type: none"> - Engine cowling condition - Propeller, blades and spinner condition (no blade cracks, no leading edge protection damages) - Engine mount and exhaust manifold condition - Oil quantity check <div style="border: 1px dashed black; padding: 10px; margin: 10px 0;"> <p style="text-align: center;">NOTE</p> <p style="text-align: center;">Oil level check requires to open the oil access hatch and remove the oil filler cap. Then the engine is manually rotated slowly in the normal direction of rotation until a gurgling sound is heard. Only then the dip stick correctly indicates the amount of oil.</p> </div> <ul style="list-style-type: none"> - Visual coolant quantity check - Inlets free of obstructions - Fuel system draining / Gascollator - Nose gear condition 				
③	<ul style="list-style-type: none"> - Wing surface condition - Leading edge condition - Stall strips condition - Check actual fuel quantity to correspond to indication (open filler cap) - Check filler cap closing - Check fuel vent openings 				
④	<table style="width: 100%; border: none;"> <tr> <td style="width: 40%; vertical-align: top;"> <ul style="list-style-type: none"> - Wing tip - Aileron - Flap </td> <td style="vertical-align: top;"> <ul style="list-style-type: none"> - surface condition, attachment, light attachment - surface condition, attachment, clearance, free movement trim tab condition - surface condition, attachment, clearance, hinge bolts secure </td> </tr> </table> <div style="border: 1px dashed black; padding: 10px; margin: 10px 0;"> <p style="text-align: center;">NOTE</p> <p style="text-align: center;">The left flap has a one degree offset versus the right flap. The left flap when retracted is about 7mm below the stub wing contour. The the right wing is streamlined</p> </div> <table style="width: 100%; border: none;"> <tr> <td style="width: 40%; vertical-align: top;"> <ul style="list-style-type: none"> - Wing locker </td> <td style="vertical-align: top;"> <ul style="list-style-type: none"> - check loading, - inspect drain hole - lock </td> </tr> </table>	<ul style="list-style-type: none"> - Wing tip - Aileron - Flap 	<ul style="list-style-type: none"> - surface condition, attachment, light attachment - surface condition, attachment, clearance, free movement trim tab condition - surface condition, attachment, clearance, hinge bolts secure 	<ul style="list-style-type: none"> - Wing locker 	<ul style="list-style-type: none"> - check loading, - inspect drain hole - lock
<ul style="list-style-type: none"> - Wing tip - Aileron - Flap 	<ul style="list-style-type: none"> - surface condition, attachment, light attachment - surface condition, attachment, clearance, free movement trim tab condition - surface condition, attachment, clearance, hinge bolts secure 				
<ul style="list-style-type: none"> - Wing locker 	<ul style="list-style-type: none"> - check loading, - inspect drain hole - lock 				
⑤	<table style="width: 100%; border: none;"> <tr> <td style="width: 40%; vertical-align: top;"> <ul style="list-style-type: none"> - Landing gear - Wing lower surface and fuselage bottom surface condition - Static port </td> <td style="vertical-align: top;"> <ul style="list-style-type: none"> - Check for condition damage - wheel attachment, brakes, condition and pressure of tires - no obstructions </td> </tr> </table>	<ul style="list-style-type: none"> - Landing gear - Wing lower surface and fuselage bottom surface condition - Static port 	<ul style="list-style-type: none"> - Check for condition damage - wheel attachment, brakes, condition and pressure of tires - no obstructions 		
<ul style="list-style-type: none"> - Landing gear - Wing lower surface and fuselage bottom surface condition - Static port 	<ul style="list-style-type: none"> - Check for condition damage - wheel attachment, brakes, condition and pressure of tires - no obstructions 				

⑥	<ul style="list-style-type: none">- Vertical tail unit - Horizontal tail unit (mass)	<ul style="list-style-type: none">- condition of surface, attachment, free rudder movement (press tail down to have nose gear free), rudder stops, antenna- condition of surface, attachment, free elevator movement, elevator stops- check attachment of elevator tips balance)- Check trim/anti-servo tab- Check free movement of tap for full elevator movement
	<p>The check on left side of the fuselage and wing is the same as on right side except on left wing:</p> <ul style="list-style-type: none">- Check pitot tube condition	

4.4 Normal procedures and check list

4.4.1 Before engine starting

1. Luggage secured
2. Rudder pedal position - set

WARNING

Adjusting of rudder pedals position during flight is PROHIBITED.
Make sure the pedals are set symmetrically

3. Safety harness - tighten
4. Control system - free & correct movement
5. Canopy - LOCKED
6. Brakes - fully applied and locked

4.4.2 Use of external power

NOTE

The external power does not charge the battery. Engine start with a completely depleted battery and no engine indication is not advised.

WARNING

The external power connection and disconnection is only possible with the outside person temporarily out of sight from pilot station. If an outside person is used a clear coordination before the operation between the pilot and the outside help is mandatory. The outside person is advised to always keep one hand on the left wing leading edge as visible sign to the pilot of a safe position. Under no circumstances the outside person shall move other than along the leading edge when engine is running. Removal of the external power connection with engine running is not advised.

4.4.3 Engine starting

NOTE

The engine manufacturer limits engine starting to an ambient temperature <50°C and oil temperature >25°C

1. Circuit breakers - CHECK
2. Master switch - ON
3. PFD - Wait for boot sequence and confirm fuel QTY matches with preflight visual check

Document No.: ADXC-73-001-AFM	Non-approved page	Revision: A
	4-6	Date of Issue: 01.10.2020

NOTE

Fuel qty above 45liter (per tank) is indicated as "+45liter".

4. DIMMER - Adjust

NOTE

The dimming slope of the LED indication lights is set to a lesser effect for master caution and warning which can cause that the other lights which are not illuminated during startup are set too low.

5. Fuel Selector - set to LEFT fuel tank

NOTE

Return fuel line goes into the Left fuel tank. Do not start the engine nor perform the take-off with the fuel selector set to the Right tank if the Left tank is full, because returning fuel will overpressure Left tank and fuel will leak from fuel tank air vent tube at the wing tip.

6. Fuel pump switch - ON – monitor fuel pressure
7. Choke (cold engine) - pull to open and lock
8. Propeller control - fine pitch (fully forward)
9. Throttle - Closed, max 5mm
10. Strobe light - ON

NOTE

The power consumption of the strobe lights cause a fluctuating sound of the fuel pump

11. Starter - hold activated to start the engine until engine fires
12. Oil pressure - Check rise within 10sec

NOTE

Oil pressure with a cold engine could be high. A maximum of 7bar is acceptable

13. Throttle - adjust for smooth running at 2000 RPM
14. Choke - Release after engine runs uniformly
15. Fuel Pump - OFF

Document No.: ADXC-73-001-AFM	Non-approved page	Revision: A
	4-7	Date of Issue: 01.10.2020

CAUTION

The starter should be activated for a maximum of 10 sec., followed by 2 min. pause for starter and starter circuit cooling.

As soon as engine runs, adjust throttle to achieve smooth running at approx. 2000 rpm. Check the oil pressure, which should increase within 10 sec.

Start the engine with the throttle lever set for idling or 5mm open at maximum, then wait 3 sec to reach constant engine speed before new acceleration.

4.4.4 Before Taxying

1. Avionics switch - ON
2. MFD - Select engine screen
3. Voltage - Check minimum 11.0V
4. ALT-1 switch - ON
5. Voltage - Check increase, nom. 13.4V
6. ALT-2 switch - ON
7. Voltage - Check increase, nom. 13.8V,max. 14.1V
8. EFIS-L3 switch - ON
9. Cockpit lights - as required (Dimmers, Day/night switch)
10. Nav Light (at night) - as required
11. Landing/Taxi Light - as required

4.4.5 Taxiing

Apply power and brakes as needed. Keep engine speed <2500RPM until oil temperature reaches 50°C. Apply brakes to control movement on ground. Taxi carefully when wind velocity exceeds 20 knots (10 m/s). Hold the control stick in neutral position, or in a position that properly deflects a crosswind.

Checks during Taxi:

1. Ground control - check nose gear steering
2. Brakes - check function
3. Indication - check attitude and direction indication on PFD/MFD and L3

Document No.: ADXC-73-001-AFM	Non-approved page	Revision: A
	4-8	Date of Issue: 01.10.2020

4.4.6 Before take-off / Engine run up:**CAUTION**

The engine run up check should be performed with the aircraft heading upwind and not on a loose terrain (the propeller may suck grit, which can damage the leading edges of blades).

1. Oil Temperature - minimum 50°
2. Propeller control - set fine pitch (full forward)
3. El. Fuel Pump - off
4. Park break - set on
5. Throttle - Set engine speed 4000RPM
6. Ignition Left/Right - Check maximum drop 300RPM, maximum difference 115RPM
7. Ignition - Both
8. Carburettor heat - on (pull),
check speed drop min 150RPM
stabilize off push
check speed regain to 4000RPM
9. Propeller control - cycle minimum 4 times over full
range
check speed drop minimum
200RPM
10. Throttle - set maximum power
check swift power acceleration
check speed minimum 5500RPM
check engine parameters in limits
11. El. Fuel pump - on, check pressure
12. Fuel Selector - set to LEFT fuel tank

NOTE

The engine fuel return line goes into the left fuel tank. Do not operate the engine with the fuel selector set to the right tank if the left tank is full. Returning fuel will overflow the left tank.

Cockpit preparation:

1. Altimeter - set
2. Instruments - CHECK

Document No.: ADXC-73-001-AFM	Non-approved page	Revision: A
	4-9	Date of Issue: 01.10.2020

- | | |
|---|--|
| <ol style="list-style-type: none"> 3. Trim 4. Control system 5. Cockpit canopy 6. Safety harness 7. Rescue system 8. Passenger briefing 9. Engine instruments 10. Wing flaps 11. Autopilot (if installed) <ul style="list-style-type: none"> ○ Flight controls ○ AP Disconnect (any trim) ○ CWS button ○ CWS button | <ul style="list-style-type: none"> - set pitch for take-off position (marking at fourth LED from the top) - set roll trim to neutral - check free movement - closed & locked - tighten - remove and store safety pin - explain rescue system - CHECK within limits - 10° - Engage - CHECK (verify autopilot can be overpowered in both pitch and roll) - PRESS (verify autopilot disengages and audio alert is heard) - PRESS LONG (verify autopilot disengages temporarily) - PRESS SHORT (verify autopilot disengages) |
|---|--|

NOTE

Take off or Landing with Autopilot active is not permissible

4.4.7 Take-off

- | | |
|--|---|
| <ol style="list-style-type: none"> 1. Brakes 2. Carburettor heat 3. Propeller control 4. Airspeed indication 5. Throttle 6. Nose wheel unstick 7. Airplane lift-off 8. Initial Climb | <ul style="list-style-type: none"> - release - Closed - full forward - check airspeed "alive" - full power - 40 KIAS - 50 KIAS - 64KIAS |
|--|---|

Document No.: ADXC-73-001-AFM	Non-approved page	Revision: A
	4-10	Date of Issue: 01.10.2020

- 9. Wing flaps - retract when speed of Vy 74 KIAS is reached, at no less than 150 ft AGL
- 10. Fuel pump switch - off

NOTE

Switching the fuel pump off will cause a transient condition on the fuel pressure potentially resulting in low fuel pressure warning. A 5sec delay until, pressure regain to safe limits is permissible.

- 11. Fuel pressure - Check

4.4.8 Short and Soft field take-off:

- 1. Use all available runway
- 2. Heading - set
- 3. Flaps - 10°
- 4. Trim - as required
- 5. Hold brakes
- 6. Carburettor heat - Closed
- 7. Propeller control - full forward
- 8. Throttle - fully forward
- 9. Release brakes after RPM increase
- 10. Accelerate and pull control stick aft to lift off the nose wheel as soon as possible.
- 11. As aircraft becomes airborne, level off in ground effect to accelerate to:
 - No obstacle: best rate of climb (Flap 10°) 75 KIAS
 - Obstacle: best angle of climb (Flap 10°) 64 KIAS
- 12. Trim - adjust
- 13. Flaps - retract at Vy 74 KIAS or at 150 ft
- 14. Fuel pump - off
- 15. Fuel pressure - check

4.4.9 Climb

- 1. Climbing speed - Vy best ROC speed 74 KIAS
Vx best angle of climb 62 KIAS
- 2. Throttle - full forward

Document No.: ADXC-73-001-AFM	Non-approved page	Revision: A
	4-11	Date of Issue: 01.10.2020

3. Prop control
 - set engine speed
 - max. 5800 RPM for 5 minutes
 - max. continuous 5500 RPM

NOTE

engine speed with manifold pressure >29"Hg is minimum 5200 RPM

4. Trim
 - trim the airplane
5. Instruments
 - oil temperature and pressure, cylinder head/coolant temperature within limits

CAUTION

If the cylinder head temperature/coolant temperature or oil temperature approach their limits, reduce the climb angle to increase airspeed and thus fulfil the limits.

4.4.10 Cruise

1. Fuel selector
 - LEFT or RIGHT.

NOTE

It is recommended to switch between tanks in regular intervals of about 25min on left and 20min on right tank during flight to consume fuel equally from both tanks.

Note: engine fuel return line ONLY dumps to the left tank which means that while running on the right tank some fuel is transferred to left tank.

This is amount 5liter/h and will cause that the total time on the left tank is higher than on the right tank.

An illumination of the low fuel caution light indicates that approx. 6liter are left in the respective tank giving a 15min remaining flight time on the respective tank.

2. Throttle
 - Set as desired
3. Prop control
 - Set engine speed maximum 5500RPM
(min 5200 for MAP>29"Hg)
(min 4650 for MAP>27"Hg)
4. Fuel flow
 - Check

NOTE

The throttle and propeller control levers are located on the quadrant between the seats. Their position is held by a friction system. Failure of the friction system or creeping control setting warrants according maintenance action.

Document No.: ADXC-73-001-AFM	Non-approved page	Revision: A
	4-12	Date of Issue: 01.10.2020

Refer to Section 5, for recommended cruising regimes.

4.4.11 Descent

- | | |
|-----------------|---------------------------------------|
| 1. Throttle | - Reduce (15...17"Hg) |
| 2. Prop control | - Set engine speed maximum
5000RPM |
| 3. Airspeed | - Set (90..100KIAS) |

CAUTION

It is not advisable to reduce the engine throttle control lever to minimum when descending from very high altitude. In such cases the engine temperatures get too low and a loss of power may occur. Descent at 15..to 17inHg manifold pressure and airspeed of 90KIAS to 100KIAS results in approximately 500ft/min descent

CAUTION

Descending for extended periods of time at higher RPM can lead to exceeding EGT maximum limit. Reduce RPM accordingly.

4.4.12 Before landing

- | | |
|-----------------------|---------------|
| 1. Seat belt | - Tighten |
| 2. Cockpit | - Prepare |
| 3. Autopilot | - Disengage |
| 4. Throttle | - as required |
| 5. Electric fuel pump | - ON |
| 6. Landing light | - ON |
| 7. Carburettor Heat | - ON |

In final approach:

- | | |
|------------------|---|
| 8. Wing flaps | - Set 25° |
| 9. Speed | - 60 KIAS |
| 10. Trim | - as needed |
| 11. Prop Control | - Set MAX (forward) |
| 12. Throttle | - Set approx. 7inHG, Maintain
RPM>2600 |

Document No.: ADXC-73-001-AFM	Non-approved page	Revision: A
	4-13	Date of Issue: 01.10.2020

4.4.13 Balked landing (Go around)

1. Throttle - full forward
2. Carburettor heat - OFF
3. Speed - accelerate to 65KIAS
4. Wing flaps - Set 10°
5. Trim - adjust as needed

4.4.14 Landing

1. Throttle - close
2. Touch-down - on main wheels
3. Brakes - Apply as needed
4. Flaps - Retract

4.4.14.1 Short field landing:

1. Throttle - fully close before flare
2. Touch down - on main wheels
3. Flare - minimum float
4. After touchdown - stick forward
5. Maximum braking
6. Retract flaps

4.4.14.2 Soft field landing:

1. Touch down - on main wheels
2. Flare - expect excessive ground friction.
To avoid violent nose gear drop
add power before touchdown to
keep elevator effective to help
keep weight off nose wheel,
3. After touchdown - throttle to idle
gradually increase back elevator
to keep weight off nosewheel
Avoid braking during roll out
4. Retract flaps

4.4.15 After landing

1. Engine speed - SET as required for taxiing
2. Carburettor heat - OFF
3. Landing light - as required for taxi

Document No.: ADXC-73-001-AFM	Non-approved page	Revision: A
	4-14	Date of Issue: 01.10.2020

4.4.16 Shutdown

- | | |
|----------------------|------------------------------------|
| 1. Propeller control | - FINE PITCH (fully forward) |
| 2. Engine speed | - IDLE |
| 3. El. pump | - OFF |
| 4. Instruments | - engine instruments within limits |
| 5. Ignition | - OFF |
| 6. Alt-1 and Alt-2 | - OFF |
| 7. Avionics | - OFF |
| 8. EFIS-L3 | - OFF |
| 9. Lights | - OFF |
| 10. Master switch | - OFF |
| 11. Park brake | - SET |

CAUTION

Rapid engine cooling should be avoided during operation. This happens above all during aircraft descent, taxiing, low engine speed or at engine shutdown immediately after landing.

Under normal conditions the engine temperatures stabilize during descent, taxiing and at values suitable to stop engine by switching the ignition off. If necessary, cool the engine at 2500 - 2750 RPM to stabilize the temperatures prior to engine shut down.

4.4.17 Aircraft parking and tie-down

- | | |
|------------------------|------------------|
| 1. Ignition check | - OFF |
| 2. Master switch check | - OFF |
| 3. Parking brake | - SET |
| 4. Canopy | - CLOSE and LOCK |
| 5. Secure the airplane | |

NOTE

It is recommended to use parking brake (if installed) for short-time parking only, between flights during a flight day. After ending the flight day or at low temperatures of ambient air, do not use parking brake, but use the wheel chocks instead.

Document No.: ADXC-73-001-AFM	Non-approved page	Revision: A
	4-15	Date of Issue: 01.10.2020

NOTE

Use anchor eyes on the wings and fuselage rear section to fix the airplane. Move control stick forward and fix it together with the rudder pedals. Make sure that the cockpit canopy is properly closed and locked.

4.4.18 Flight in rain

When flying in the rain, no additional steps are required. Aircraft qualities and performance are not substantially changed. However Visual Meteorological Condition (VMC) must be maintained.

Document No.: ADXC-73-001-AFM	Non-approved page	Revision: A
	4-16	Date of Issue: 01.10.2020



AIRCRAFT FLIGHT MANUAL

BRISTELL B23

INTENTIONALLY LEFT BLANK

Document No.: ADXC-73-001-AFM	Non-approved page	Revision: A
	4-17	Date of Issue: 01.10.2020

SECTION 5

5 PERFORMANCE

5.1	<i>Introduction</i>	5-1
5.1.1	ISA Conversion.....	5-2
5.1.2	Pressure to density altitude conversion.....	5-3
5.2	<i>Approved data</i>	5-4
5.2.1	Airspeed indication system calibration	5-4
5.2.2	Stall speeds	5-5
5.2.3	Performance reference values	5-6
5.2.4	Take-off performance.....	5-7
5.2.5	Landing distances.....	5-8
5.2.6	Climb performance	5-9
5.3	<i>Additional information</i>	5-11
5.3.1	Cruise	5-11
5.3.2	Endurance	5-12
5.3.3	Balked landing climb	5-14
5.3.4	Effect on flight performances and characteristics caused by rain or accumulation of insects.....	5-15
5.3.5	Demonstrated crosswind performance.....	5-16
5.3.6	Noise data	5-17

5.1 *Introduction*

Section 5 provides approved data for airspeed calibration, stall speeds and take-off performance as well as non-approved additional information.

The data in the charts has been computed from actual flight tests with the aeroplane and engine in good condition and using average piloting techniques.

In this section the term

- maximum continuous power MCP is synonym with wide open throttle (WOT) at engine speed of 5500RPM
- maximum take off power MTOP is synonym with wide open throttle (WOT) at engine speed of 5800RPM

Unless otherwise specified all data given refers to standard day condition (ISA) at zero wind speed.

Unless otherwise specified altitude depended data is given over density altitude which is a function of pressure altitude and outside air temperature.

Document No.: ADXC-73-001-AFM	Non-approved page	Revision: A
	5-1	Date of Issue: 01.10.2020

5.1.1 ISA Conversion

The offset from ISA condition can be determined with actual outside temperature and pressure altitude using the following diagram.

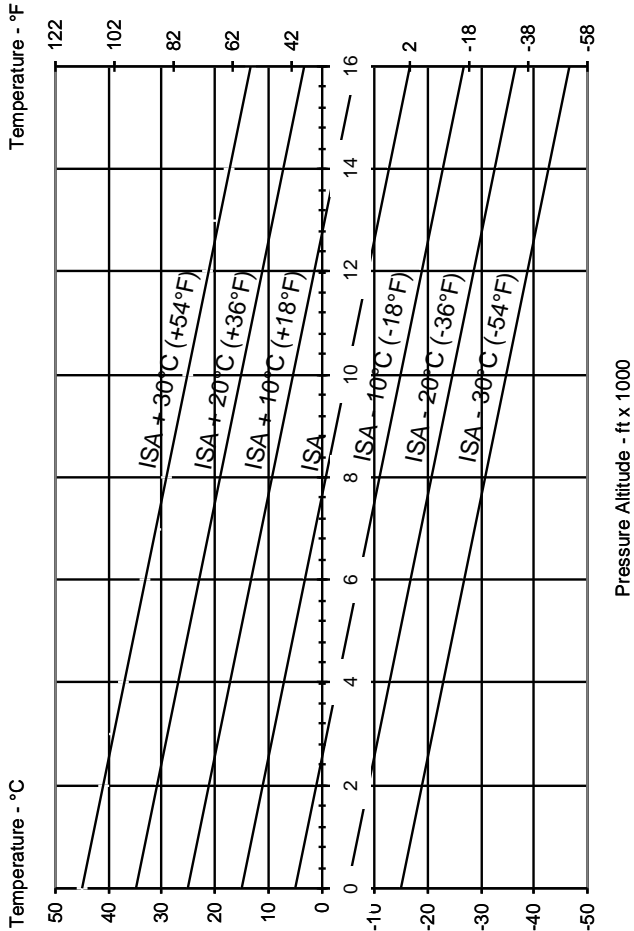

Document No.: ADXC-73-001-AFM	Non-approved page	Revision: A
	5-2	Date of Issue: 01.10.2020

5.1.2 Pressure to density altitude conversion

Procedure:

- A.) determine pressure altitude by ISA-conversion
- B.) determine intersection of outside air temperature with isobar line
- C.) read density altitude on right side of diagram

Example: pressure altitude = 8500ft, outside air temp. = -6°C; result: density altitude = 8000ft

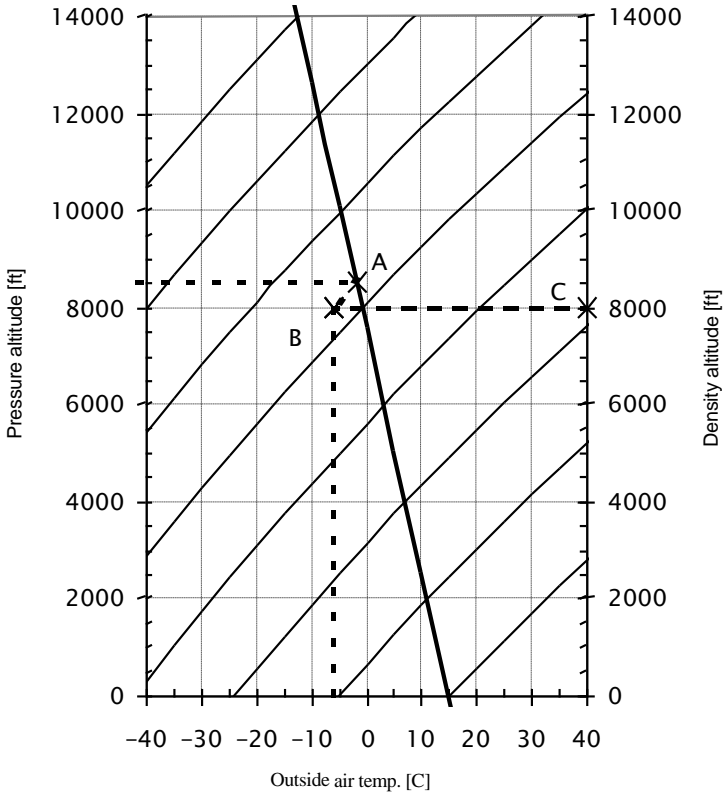

Document No.: ADXC-73-001-AFM	Non-approved page	Revision: A
	5-3	Date of Issue: 01.10.2020

5.2 *Approved data*

5.2.1 Airspeed indication system calibration

The airspeed indication system error is only little depended on power setting and not noteworthy depended on flap setting.

For low airspeed with engine idle as well as high speed (>100KIAS) and high power setting the error is less than 1 knot.

	KIAS Power OFF	KIAS Power ON	KCAS
VS0	44	48	43
	47	50	46
VS1 (Flap 0)	51	54	50
	61	63	60
	71	72	70
VFE	82	83	81
	91	92	90
VA	99	100	98
	111	112	110
	121	121	120
	131	131	130
VNO	136	136	135
	141	141	140
	151	151	150
VNE	157	157	156

NOTE

Data presented assumes the error of the indicator itself being zero

5.2.2 Stall speeds

Wing level stall speeds are based on flight testing.

Turning flight stall speeds are computed from wing level stall speeds and load factor developed at turn.

CONDITIONS: MTOW 750 kg Engine at idle	Wing flaps position	Stall speed		Altitude loss at recovery
	[°]	KIAS	KCAS	[ft]
WING LEVEL STALL	0	51	50	260
	10	47	46	280
	25	44	43	280
CO- ORDINATED TURN, 30° BANK	0	55	54	220
	10	50	49	220
	25	47	46	220

5.2.3 Performance reference values

Flaps 0°

(Sea level, ISA conditions, 750kg, MCP 5500rpm)

V _Y	74	klAS
Best ROC (sea level)	688	ft/min
V _X	62	klAS
Best angle of climb (sea level)	10.4%, 5.91°	
V _H (sea level)	117	klAS
Best glide speed	67	klAS

(Sea level, ISA conditions, 750 kg, MTOP 5800rpm)

CAUTION

MTOP (5800rpm) may be used for max 5min!

Best ROC speed	74	klAS
Best ROC (sea level)	702	ft/min
Best angle of climb speed.....	62	klAS
Best angle of climb (sea level)	10.4%, 5.92°	

Flaps 10°

(Sea level, ISA conditions, 750kg, MCP)

Best ROC speed	75	klAS
Best ROC (sea level)	625	ft/min
Best angle of climb speed.....	64	klAS
Best angle of climb (sea level)	9.1%, 5.17°	

(Sea level, ISA conditions, 750 kg, MTOP 5800rpm, balked landing performance)

Best ROC speed	76	klAS
Best ROC (sea level)	634	ft/min
Best angle of climb speed.....	65	klAS
Best angle of climb (sea level)	9.1%, 5.20°	

5.2.4 Take-off performance

Take off distances are based on flight test at MTOW corrected for ISA/SL conditions.

Conditions:

Wind..... NIL
 Runway.....dry and level
 Flaps..... Take-off 10°
 Brakes..... held while applying the power
 Throttle..... full
 Speed at 50ft height..... 65 KIAS

Take-off run distance		Take-off distance over 50 ft (15 m) obstacle	
m	ft	m	ft
365	1198	479	1572

Correction factors for varying conditions

Factors to be applied to take off distance over 50ft

Grass Runway 1.14
 Uphill slope (per each 1 % of slope) 1.05
 Downhill slope (per each 1% of slope) 0.95
 Decrease distance per 5KTS headwind..... 15%
 Increase distance per 5KTS tailwind..... 20%

Take off performance dependent on altitude and temperature

TOW = 750 kg	Field Altitude [ft]	Outside air temperature [° C]				
		ISA - 20	ISA - 10	ISA	ISA +10	ISA + 20
Ground Roll [m]	0	309	335	365	396	431
	2000	362	396	432	475	522
	4000	431	476	526	584	652
	6000	525	587	661	747	852
Distance to clear a 15-m obstacle [m]	0	400	438	479	523	570
	2000	470	515	562	616	675
	4000	554	610	671	739	818
	6000	663	735	818	915	1030

5.2.5 Landing distances

Landing distances are based on flight test at MTOW corrected for ISA/SL conditions.

Conditions:

Wind..... NIL

Runway.....dry and level

Flaps..... Landing 25°

Final approach speed 58 KIAS

Landing distance from over 50 ft (15 m) obstacle		Landing distance Ground roll	
m	ft	m	ft
391	1283	146	479

Correction factors for varying conditions

Factors to be applied landing distance over 50ft

Grass runway..... 1.18

Uphill slope (per each 1 % of slope)0.95

Downhill slope (per each 1 % of slope) 1.05

Wet runway..... 1.15

Decrease distance per 5KTS headwind..... 5%

Increase distance per 5KTS tailwind..... 10%

Landing distances depend on altitude and temperature

Landing weight = 750 kg	Field Altitude [ft]	Outside air temperature [° C]				
		ISA - 20	ISA - 10	ISA	ISA +10	ISA + 20
Ground Roll [m]	0	136	141	146	151	157
	2000	146	151	157	163	169
	4000	157	163	169	175	182
	6000	169	175	182	189	196
Distance to clear a 15-m obstacle [m]	0	362	376	391	405	419
	2000	389	405	420	436	451
	4000	419	436	453	469	485
	6000	452	470	488	505	523

5.2.6 Climb performance

Climb performance, Flaps 0°

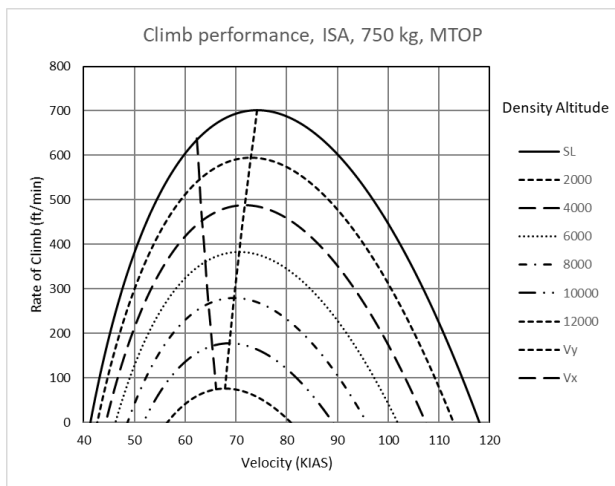
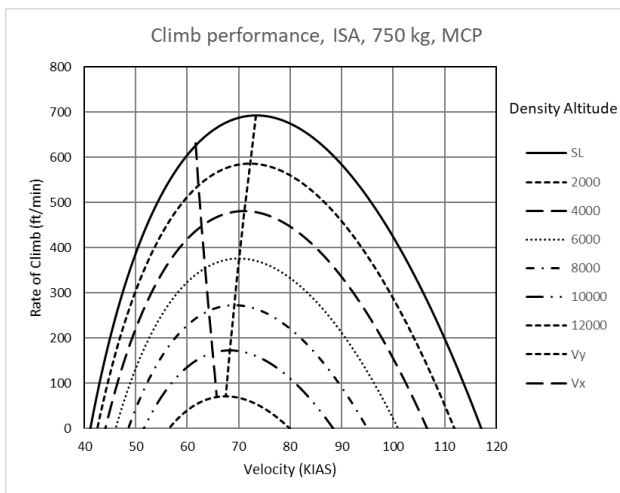

CAUTION

MTOP (5800rpm) may be used for max 5min!

Document No.: ADXC-73-001-AFM	Approved page	Revision: A
	5-9	Date of Issue: 23.09.2020

Time to Climb, ISA, 750 kg TOW

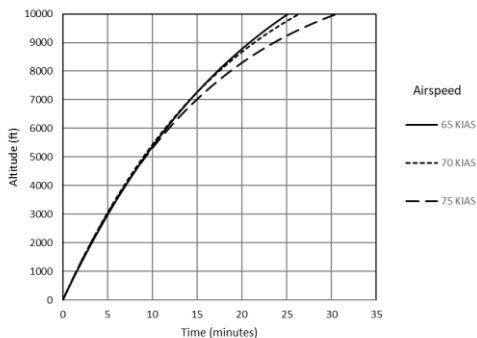

Condition MCP

Note: the shortest possible time to a given altitude requires permanent adjustment of airspeed along line of best rate of climb, see climb performance graph

Distance to Climb, ISA, 750 kg TOW

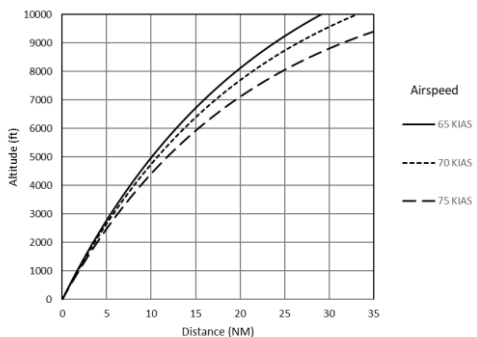

Condition MCP

Note: the shortest possible distance to a given altitude requires permanent adjustment of airspeed along line of best angle of climb, see climb performance graph

Fuel to Climb, ISA, 750 kg TOW

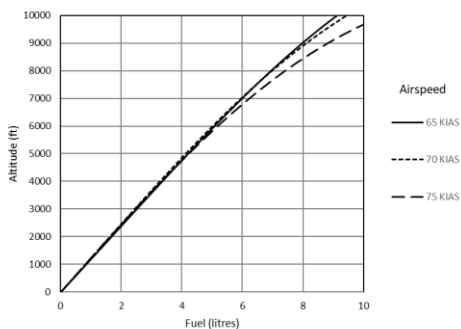

Condition MCP

5.3 Additional information

5.3.1 Cruise

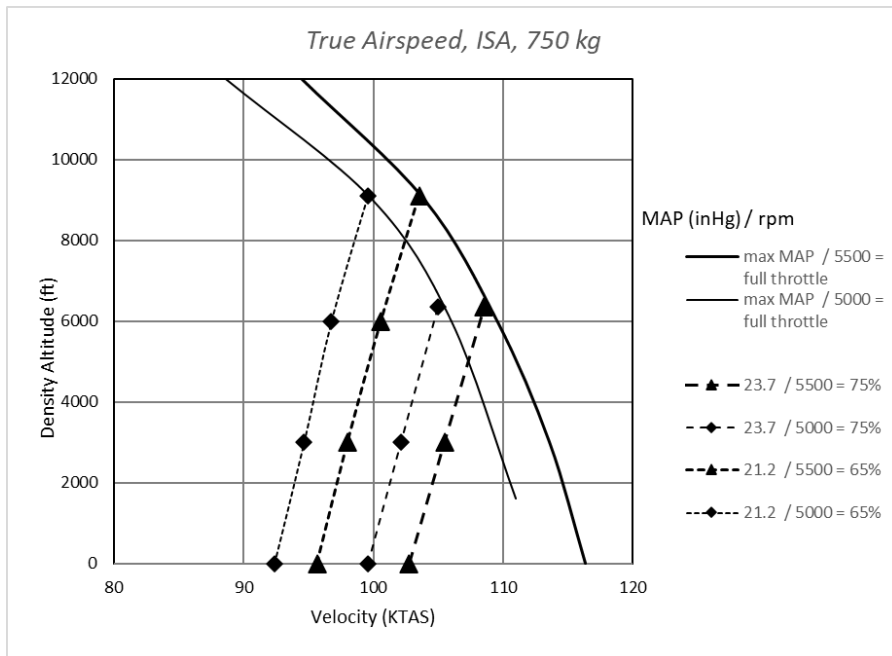

NOTE

With manifold pressure at 29" engine speed may not be less than 5200RPM
 With manifold pressure at 27" engine speed may not be less than 4650RPM
 At 5000PPM manifold pressure may not exceed 28.5"

5.3.2 Endurance

Conditions:

- No specific allowance of fuel burn for start-up and taxi
- Initial climb to altitude @ MCP (full throttle, 5500rpm)
- Initial climb-out at V_Y
- Descent fuel flow 10l/h
- 30 minutes reserve (fuel flow corresponding to the range/endurance point)
- The range and endurance include the time/distance covered during climb

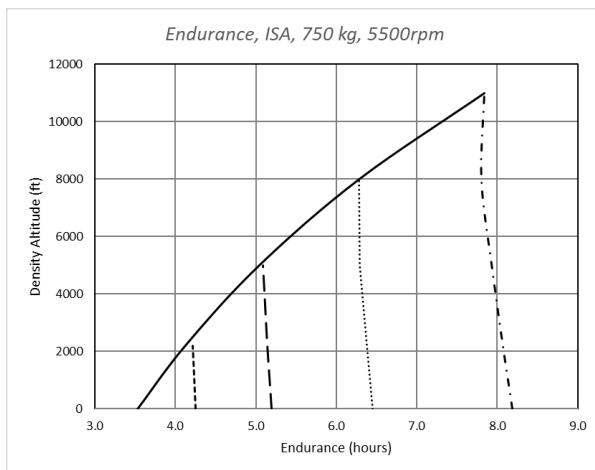
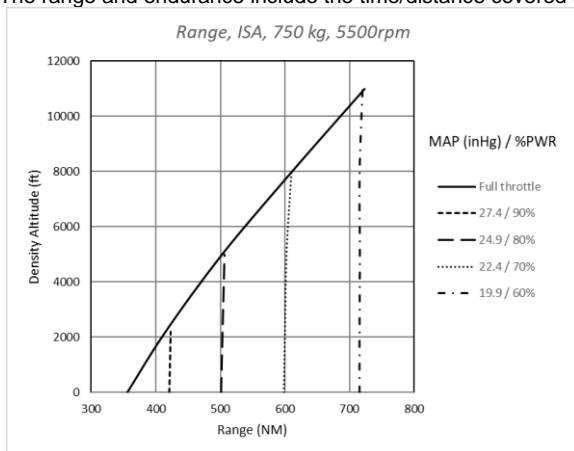

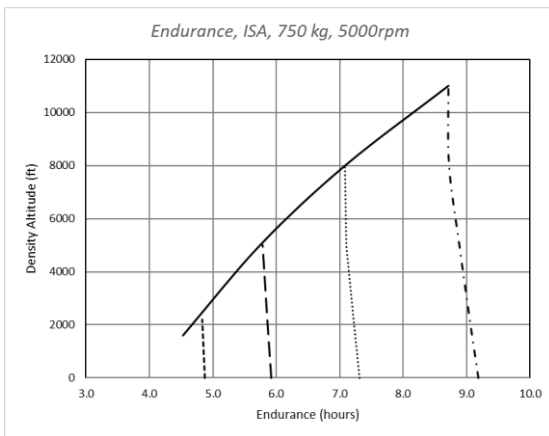
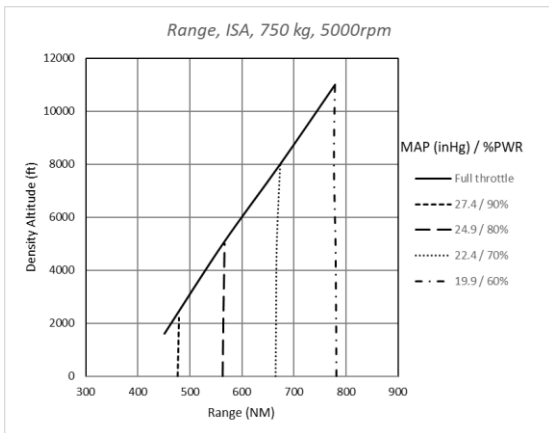

NOTE

With manifold pressure at 29" engine speed may not be less than 5200RPM
 With manifold pressure at 27" engine speed may not be less than 4650RPM
 At 5000PPM manifold pressure may not exceed 28.5"

5.3.3 Bailed landing climb

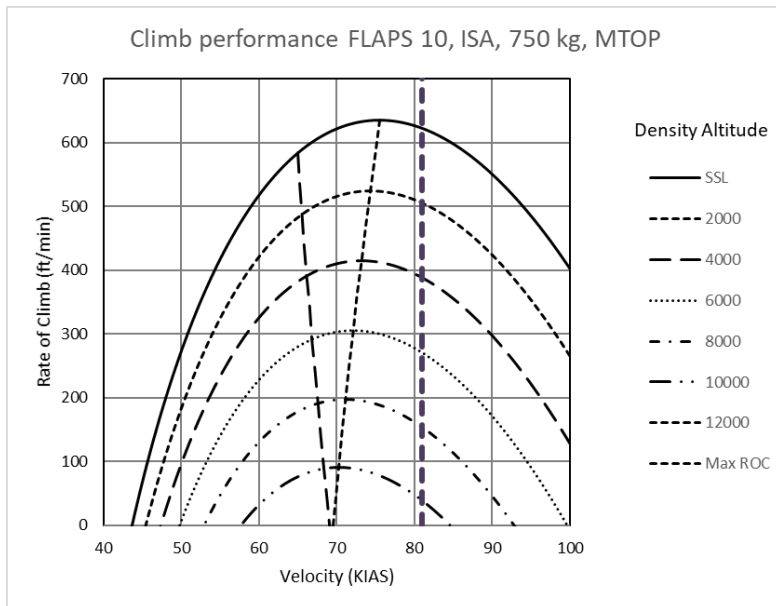

Refer to 5.2.3 for reference data

5.3.4 Effect on flight performances and characteristics caused by rain or accumulation of insects.

Performance data in this flight manual has been determined with an airplane in good condition but without surface painting. During flight test no noteworthy degradation due to wet or dirty aircraft has been noted neither in performance nor in flight characteristics.

The lifting surface cross sections employed on the B23 are not known to be specifically susceptible to such degradation.

Document No.: ADXC-73-001-AFM	Non-approved page	Revision: A
	5-15	Date of Issue: 01.10.2020

5.3.5 Demonstrated crosswind performance

Maximum demonstrated crosswind speed: **9kts**

NOTE

The stated cross wind component may or may not be limiting. Actual use of the airplane in high crosswind condition is subject to pilot skill.

Document No.: ADXC-73-001-AFM	Non-approved page	Revision: A
	5-16	Date of Issue: 01.10.2020

5.3.6 Noise data

The noise level of the B23, according to ICAO Annex 16, Chapter X, amounts to 69.2dB(A).

Document No.: ADXC-73-001-AFM	Non-approved page	Revision: A
	5-17	Date of Issue: 01.10.2020

SECTION 6

6 WEIGHT AND BALANCE

6.1	<i>Introduction</i>	6-1
6.2	<i>Definitions.....</i>	6-1
6.3	<i>Airplane weighing procedure.....</i>	6-2
6.4	<i>Empty aircraft weight and balance record</i>	6-3
6.5	<i>Loaded Aircraft Weight and CG</i>	6-4
6.6	<i>Equipment list.....</i>	6-6

6.1 Introduction

This section contains information about the aircraft empty weight and centre of gravity as well as the procedure for its determination.

In addition, the method for determination of airplane operational weight and balance is given.

The range within the airplane may be safely operated is defined in section 2 „Limitations“

6.2 Definitions

The basic airplane empty weight is defined as the empty aircraft with full engine operational required fluids (oil and coolant) as well as with the amount of unusable fuel in the fuel tanks (2*1.0liter).

The centre of gravity lever arms relate to the airplane datum located at the propeller plane. Airplane level attitude is defined as the fuselage top rivet row just below the canopy frame.

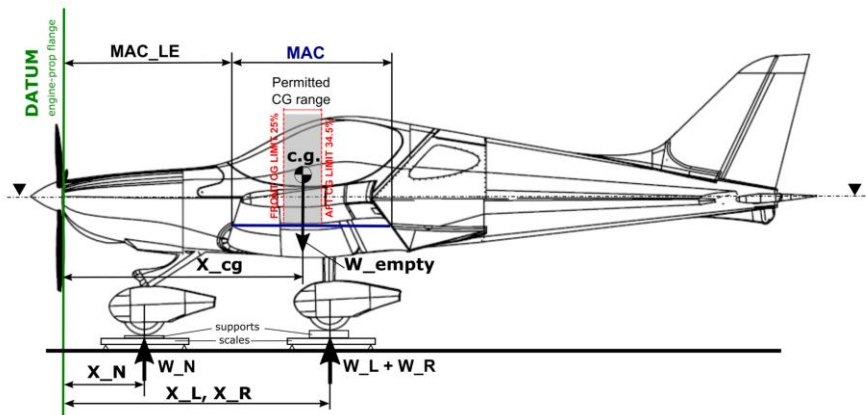

Nominal geometric lever arms and lengths are:

Nose gear ground contact X_N	0.588 m
Main gear ground contact X_L, X_R	2.062 m
MAC.....	1.343 m
MAC Leading edge (MAC_{LE}).....	1.377 m

Document No.: ADXC-73-001-AFM	Non-approved page	Revision: A
	6-1	Date of Issue: 01.10.2020

CG-locations:

Fuel.....	1.600 m
Luggage in wing locker	2.025 m
Occupant	2.085 m
Luggage in lower aft area	2.520 m
Luggage in upper aft area.....	2.800 m

6.3 Airplane weighing procedure

Procedure:

- 1.) Prepare aircraft by off-loading any luggage and loose items which are not part of the standard equipment
- 2.) Check coolant and oil filled, replenish if needed
- 3.) Drain fuel
- 4.) Level airplane on scales (reference upper rivet row below canopy frame)
- 5.) Determine individual weight on all three gears (W_N , W_L , W_R)
- 6.) Check gear lever arms (X_N , X_L , X_R ; reference propeller flange $X=0.0m$, or firewall $X=0.960m$).
- 7.) Calculate Empty Weight:

$$W_{\text{empty}} = W_N + W_L + W_R$$

- 8.) Calculate Empty airplane moment:

$$M_{\text{empty}} = W_N * X_N + W_L * X_L + W_R * X_R$$

- 9.) Calculate Empty Airplane CG:

$$CG_{\text{empty}} = M_{\text{empty}} / W_{\text{empty}}$$

- 10.) Record date, empty weight, moment and CG in the weight and balance record sheet (next page).

Document No.: ADXC-73-001-AFM	Non-approved page	Revision: A
	6-2	Date of Issue: 01.10.2020

6.5 Loaded Aircraft Weight and CG

Loaded aircraft weight and balance is determined by summing individual masses and moments and calculating according flight condition for actual fuel and zero fuel. Results shall be entered in the graph of permissible range.

To do so the following blank form and graph should be used:

	ITEM	WEIGHT (kg)	ARM (m)	MOMENT= WEIGHT x ARM (kg.m)
EMPTY AIRCRAFT WEIGHT AND CG	RIGHT MAIN WHEEL	W_R =	X_R = 2.062	M_R =
	LEFT MAIN WHEEL	W_L =	X_L = 2.062	M_L =
	NOSE WHEEL	W_N =	X_N = 0.588	M_N =
	EMPTY AIRCRAFT	EMPTY WEIGHT: W_EMPTY(KG)=	EMPTY CG: X.CG = CG(%MAC) =	EMPTY TOTAL MOMENT MT(kg.m)

	ITEM	WEIGHT (kg)	ARM (m)	MOMENT= WEIGHT x ARM (kg.m)
LOADED AIRCRAFT WEIGHT AND CG	EMPTY AIRCRAFT			
	PILOT		2.085	
	PASSENGER		2.085	
	BAGGAGE – BEHIND SEATS		2.520	
	BAGGAGE – WING LOCKERS		2.025	
	Fuel tanks		1.600	
	LOADED AIRCRAFT	TAKEOFF WEIGHT: TOW (KG) =	CENTER OF GRAVITY: X.CG = CG(%MAC) =	TOTAL MOMENT MT(kg.m) =

$$X_{CG} = \frac{\text{Total moment}}{\text{Take off weight}} = \frac{MT}{TOW}$$

$$CG_{(\%MAC)} = \frac{X_{CG} - MAC_{LE}}{MAC} * 100$$

W&B envelope limits, see below

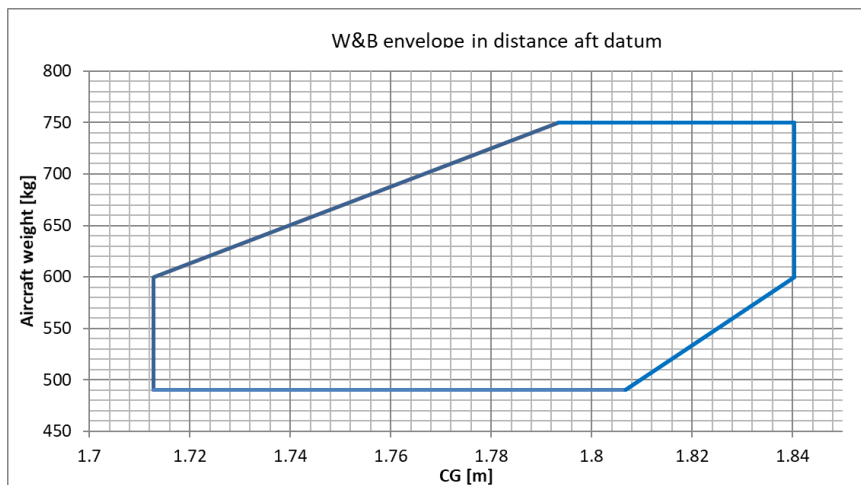
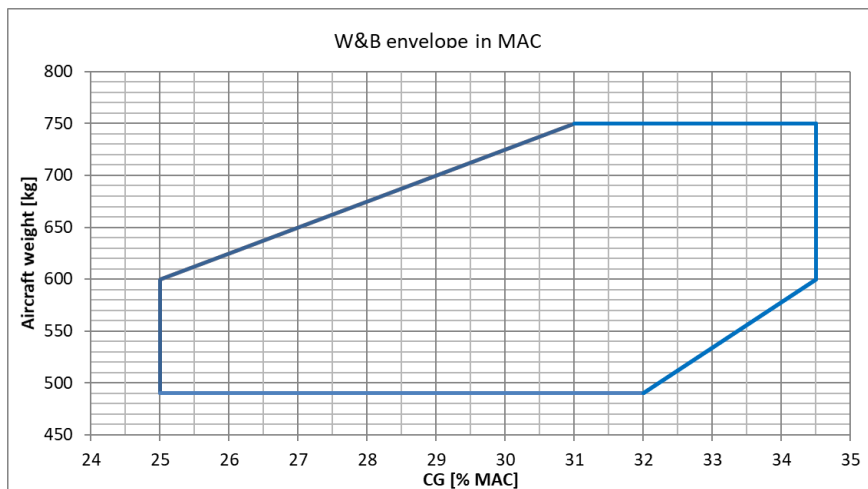

Document No.: ADXC-73-001-AFM	Non-approved page	Revision: A
	6-5	Date of Issue: 01.10.2020

6.6 *Equipment list*

List of equipment installed in BRISTELL B23, S/N

Equipment	Req Opt	Installed = X, In stal. date	Mass [kg]	Location X [m]	Serial number (if applicable)
Engine section					
Engine Rotax 912S3 (dry weight)	1 Req.	X	61.00	0.318	
Propeller	1 Req.	X	10.00	-0.117	
Governor Jihostroj P-110-051/A	1 Req.	X	1.000	0.246	
El. Fuel pump	1 Req.	X	0.315	0.935	
Fuel check valve	1 Req.	X	0.040	0.915	
Fuel flow sensor (feed)	1 Req.	X	0.160	0.835	
Fuel flow sensor (return)	1 Req.	X	0.160	0.908	
Gascollator	1 Req.	X	0.195	0.911	
External Alternator	1 Req.	X	3.000	0.091	
Cabin					
Seat belt harness	2 Req.	X	2* 0.81	2.308	
Emergency exit hammer	1 Req.	X	0.150	2.107	
Instrument panel					
Ignition switch	1 Req.	X	0.185	1.556	
Garmin PFD GDU460	1 Req.	X	2.090	1.548	
Garmin MFD GDU460	1 Req.	X	2.090	1.548	
L3 ESI-500	1 Req.	X	0.925	1.521	
Garmin Autopilot control GMC307	1 Opt.		0.227	1.553	
Garmin GNC 255 NAV/COM	1 Req.	X	1.370	1.411	
Garmin GTX 345 XPDR	1 Req.	X	1.245	1.457	
Compass Airpath C2400	1 Opt.		0.290	1.559	
Glareshield lights with Dimmer	1 Req.	X	0.055	1.67	
Elevator Trim indication	1 Req.	X	0.035	1.552	
Aileron Trim Indication	1 Req.	X	0.035	1.552	
Intercom PM3000	1 Req.	X	0.259	1.518	

Document No.: ADXC-73-001-AFM	Non-approved page	Revision: A
	6-6	Date of Issue: 01.10.2020

Equipment	Req Opt	Installed = X, In stal. date	Mass [kg]	Location X [m]	Serial number (if applicable)
In front of instrument panel					
BRS AEPS System (complete)	1 Req.	X	14.380	1.080	
Garmin engine indication GEA24	1 Req.	X	0.318	1.371	
Garmin ADHARS GSU25C	1 Req.	X	0.235	1.504	
Overvoltage voltage protection	2 Req.	X	0.145 0.145	1,31 1,38	
Encoding altimeter	1 Req.	X	0.180	1.331	
Back-Up Battery IBBS 6AH	1 Req.	X	0.967	1.125	
Floor area					
AP Servo Garmin GSA28	2 Opt.		0.614 0.614	1,858 1,943	
Wing					
Garmin GAP26 pitot tube / AoA	1 Req.	X	0.177	1.78	
NAV/Strobe lights	1R req. 1G Req.	X X	0.235 0.235	2.551 2.551	
Landing light	2 Req.	X	0.183	1.522	
L3 Magnetometer MAG-500	1 Req.	X	0.135	1.677	
Gear/Brakes					
Nose wheel 5.00-5"	1 Req.	X	4.195	0.603	
Main Wheel 5.00-5"	2 Req.	X	4.205	2.067	
Wheel brakes Berringer	2 Req.	X	0.975	2.106	
Nose gear suspension damper	1 Req.	X	0.605	0.925	
Brake cylinder	4 Req.	X	0.100	1.089	
Brake fluid reservoir	1 Req.	X	0.050	0.916	
Retrofits/Additions					

NOTE:

"Optional" refers to the commercial aspects. Equipment required for a specific operation mode is defined in Limitation section 2.17 Minimum Equipment.

Document No.: ADXC-73-001-AFM	Non-approved page	Revision: A
	6-7	Date of Issue: 01.10.2020

SECTION 7

7 AEROPLANE AND SYSTEM DESCRIPTION

7.1	<i>Introduction</i>	7-2
7.2	<i>Airframe</i>	7-2
7.2.1	Wing	7-2
7.2.2	Fuselage.....	7-3
7.2.3	Stabilizers, flaps and movable control surfaces	7-4
7.3	<i>Flight controls</i>	7-5
7.3.1	Aileron control and aileron trim	7-5
7.3.2	Elevator control and elevator trim tab control	7-5
7.3.3	Rudder control	7-5
7.3.4	Wing flap control	7-6
7.3.5	Nose wheel control	7-6
7.4	<i>Instrument panel and glare shield</i>	7-7
7.4.1	Upper panel controls and indication	7-8
7.4.2	Left side instrument panel	7-9
7.4.3	Pilot side controls.....	7-9
7.4.4	Center stack	7-9
7.4.5	Co-Pilot side controls	7-10
7.4.6	Right side instrument panel	7-11
7.4.7	Control sticks	7-11
7.4.8	Center console	7-12
7.5	<i>Landing gear system</i>	7-14
7.5.1	Main landing gear	7-14
7.5.2	Nose landing gear.....	7-14
7.5.3	Wheel brakes.....	7-14
7.5.4	Wheel fairings.....	7-14

7.6	Cockpit lay-out, Seats and safety harness,.....	7-15
7.7	Baggage compartment	7-16
7.8	Cabin	7-17
7.9	Powerplant.....	7-18
7.9.1	Engine	7-18
7.9.2	Propeller	7-20
7.10	Fuel system.....	7-21
7.11	Electrical system.....	7-24
7.11.1	Warning, caution and indication lights, internal lighting .	7-28
7.11.2	Use of back-up battery	7-29
7.11.3	External lighting	7-30
7.11.4	External Power	7-31
7.12	Pitot and static pressure systems	7-32
7.13	Miscellaneous equipment.....	7-33
7.13.1	Stall warning system	7-33
7.13.2	Airframe emergency parachute system.....	7-33
7.14	Avionics	7-34
7.14.1	L-3 EFIS, L3 ESI-500.....	7-35
7.14.2	Garmin PFD / MFD screens.....	7-38
7.14.3	Garmin GMC 307-20 Autopilot control panel (optional) .	7-42
7.14.4	Garmin GNC 255 COM/NAV	7-46
7.14.5	Garmin GTX 345 transponder	7-49
7.14.6	Intercom	7-50

7.1 **Introduction**

This section provides description and operation of the aeroplane and its systems. Refer to Section 9, Supplements, for details of optional systems and equipment.

7.2 **Airframe**

The main airframe of Bristell B 23 aircraft is an aluminium metal riveted structure.

7.2.1 **Wing**

The wing is an all-metal structure with 2 spars. The centre section of the wing is an integrated part of the fuselage. The outer part of the wing consists of nine ribs and has trapezoid shape. There are 3 main attachments (positioned on the main spar) and one rear attachment (positioned on the rear spar) where outer wing is joined with the centre section.

Fuel tanks are installed in front of the main spar on the inner third of the outer wing.

Winglets are produced from fibreglass and are riveted on the end of the wing skin. Position lights and anti-collision beacons are installed on the winglets.

Both ailerons and flaps are all-aluminium structures. They consist of skin and ribs (and spar-flaps) riveted together. Ailerons are suspended on the rear spar of the wing using piano hinges. Flaps are suspended on the rear spar on three hinges.

The aileron control pushrods are led between the spars. The aileron trim tab is installed on the left aileron. The trim tab actuator is installed inside of left aileron.

There is one common flap control actuator which is installed in the fuselage between the seats and beneath the glove box. It actuates a central torsion tube to transmit the force to the flap actuation lever located at the flap inboard root.

Wings are equipped with wing lockers placed between the second and the third rib aft of the main spar. Capacity of each wing locker is 20 kg. Access doors are suspended on two hinges. They can be locked with a latch.

Wing locker drain holes shall be inspected regular to avoid unnoticed accumulation of water.

Document No.: ADXC-73-001-AFM	Non-approved page	Revision: A
	7-2	Date of Issue: 01.10.2020

The wing leading edges feature stall strips to provide benign stall characteristics. Stall strips are symmetric in spanwise extension, but not symmetric in placement along the cross section.

7.2.2 Fuselage

The fuselage all-aluminium structure design is formed by bulkheads, stiffeners and surface sheets. The fuselage consists of the front part (between firewall and bulkhead aft of the rear windows) and the rear part (aft of the beforehand mentioned bulkhead).

Cockpit with carbon/aramid composite seats is located in the front part of the fuselage. The luggage compartment (capacity max 15 kg) is located behind the seats.

The centre section of the wing is an integral part of the fuselage and contains the main spar attachments and the rear spar attachments. Main landing gear attachment points are located behind the main spar.

Top engine mount attachment points are located on the cross channel behind the firewall. Bottom attachment points are located on the cockpit floor and connected with reinforcement channels under the floor.

The cockpit further consists of a composite structure canopy frame with an integrated back-rest for pilot and co-pilot.

The rear part of the fuselage has an elliptic cross section. The fin with rudder attachments and stabilizer attachments is an integral part of the fuselage. The last two bulkheads form the stabilizer attachment points.

A tail skid is located on the bottom aft fuselage. It is made from composite material.

Document No.: ADXC-73-001-AFM	Non-approved page	Revision: A
	7-3	Date of Issue: 01.10.2020

7.2.3 Stabilizers, flaps and movable control surfaces

The horizontal stabilizer is an all-metal structure consisting of two aluminium spars, eight ribs and aluminium skin. It is mounted on the fuselage by means of front and rear attachments. The front attachments consist of two pins - riveted on the second last bulkhead, and bushings - riveted on the front stabilizer spar. The rear attachments consist of four hinges bolted on the top and the bottom part of the last bulkhead, and riveted to rear stabilizer spar.

The elevator is attached to the rear spar of the HST using a piano hinge. The main structure is made of aluminium and consists of ribs and skin riveted together. Control lever is riveted between the middle elevator ribs. Fiberglass elevator tips equipped with mass balance are riveted on the both elevator ends. The elevator is equipped with the trim tab, which is suspended on a piano hinge on the rear spar close to the trailing edge of the elevator. The trim tab is made of aluminium and is actuated by a RayAllen electric drive integrated in the horizontal stabilizer. The trim tab also acts as anti-servo tab, increasing the stick forces with increasing deflection of the elevator. When moving the elevator the trim tab makes an additional deflection into the same direction.

The vertical fin is an aluminium structure and is an integral part of the fuselage. The fin consists of stiffeners, spar, ribs, and aluminium skin. Individual parts are riveted together. Fin tip is made of fibreglass. Two rudder hinges are integrated on the vertical spar.

Rudder is an aluminium structure and consists of spar, ribs and skin riveted together by rivets. Bottom attachment is riveted to the root rudder rib. Top attachment is located on the spar.

The flaps are likewise all aluminium. Rigging of the flaps is correct with the left flap 8mm below the corresponding stubwing surface and the right flap in line.

Document No.: ADXC-73-001-AFM	Non-approved page	Revision: A
	7-4	Date of Issue: 01.10.2020

7.3 **Flight controls**

Control System consists of an aluminium pushrods system (machined bell cranks) with a steel torque tube for aileron and elevator.

Rudder Control System consists of steel cable and pulley system. The rudder control is also used for nose gear steering in a closed loop system.

7.3.1 Aileron control and aileron trim

Ailerons are actuated with two control sticks located between the pilot's and co-pilot's legs. Movement of the control sticks is synchronized via pushrod lead between the inside of the elevator control torque tube. Lateral control stops are located on the torque tube in the cockpit.

The ailerons have differential actuation, to minimize the unwanted secondary yawing caused by aileron deflection.

The aileron trim tab is installed on the left aileron. It is controlled by the actuator located inside of the left aileron. Control switches are integrated into both stick grips.

A LED position indicator is installed on the instrument panel in the pilot's view field (independent from EFIS). The aileron trim position light intensity can be dimmed by a fixed value using the day/night switch.

7.3.2 Elevator control and elevator trim tab control

The elevator is controlled by moving the control sticks forward and aft.

A system of transmission levers and pushrods transfers the movement of control sticks to the elevator.

An electric actuator is installed in the horizontal stabilizer. It is used to control the elevator trim tab. Control switches are integrated in both stick grips.

A LED position indicator is installed on the instrument panel in the pilot's view field (independent from EFIS). The elevator trim position light intensity can be dimmed by a fixed value using the day/night switch.

The elevator trim tab serves as anti-servo-tab for the elevator, it cooperates with the elevator to enhance control force.

7.3.3 Rudder control

The rudder is controlled by means of foot control pedals. Pedal deflections are transferred to the rudder by a cable-pulley system.

Foot control pedals can be set individually to two positions (large and small pilot) by means of a lock-pin mechanism on the side wall of

Document No.: ADXC-73-001-AFM	Non-approved page	Revision: A
	7-5	Date of Issue: 01.10.2020

fuselage under the instrument panel. Setting of the rudder pedals in flight is not permissible. Non-symmetric settings (i.e. left pedal back, right pedal front) is mechanically possible but not approved for flying. The pilot upon boarding shall check the correct symmetric pedal setting.

The pedals also control the nose gear steering.

7.3.4 Wing flap control

Wing flaps are controlled by one central electric actuator connected to the flaps by a lateral torque tube with transfer pushrods on each side of the wing. The flap actuator is located in the centre channel of fuselage between the seats and is controlled by programable control unit with three positions switch (including “up”) located on the centre console. An LCD indicator is integrated to the control unit for confirmation of the positions (and transition - blinking). Wing flaps deflection can be 0°, 10°, and 25°. Additional end switches protect the system. The handle of the flap control is shaped to prevent LED reflections in the canopy. While moving the handle to the next positions reflections might be noticeable at night.

The LED brightness is adjusted by operating the right hand dimmer control.

WARNING

If the flap lever is moved while the master switch is OFF, the flap will not move to the indicated position after switching on the master. Therefore, always perform a flap operation check, as per the standard procedures after switching oncc+ the master.

NOTE

The left flap has a one degree ofset versus the right flap. This is visible with retracted flaps. The left flap has a correct position about 7mm below the stub wing contour. The ficht is fully stremlined

7.3.5 Nose wheel control

Turning of the nose wheel fork is controlled through a dual Teleflex rod (push/pull cable) which has its bottom end connected to the top of the nose wheel fork, and its upper end connected to a lever welded to the rudder control system. The nose landing gear / rudder control has a closed loop (with centring springs) system located in the same channel where the nose landing gear mounts.

Document No.: ADXC-73-001-AFM	Non-approved page	Revision: A
	7-6	Date of Issue: 01.10.2020

7.4 Instrument panel and glare shield

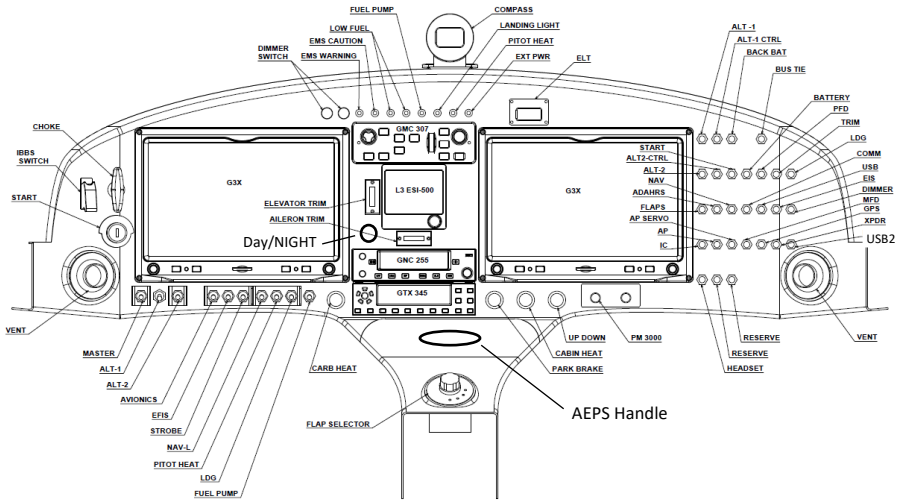

Compass and autopilot are optional

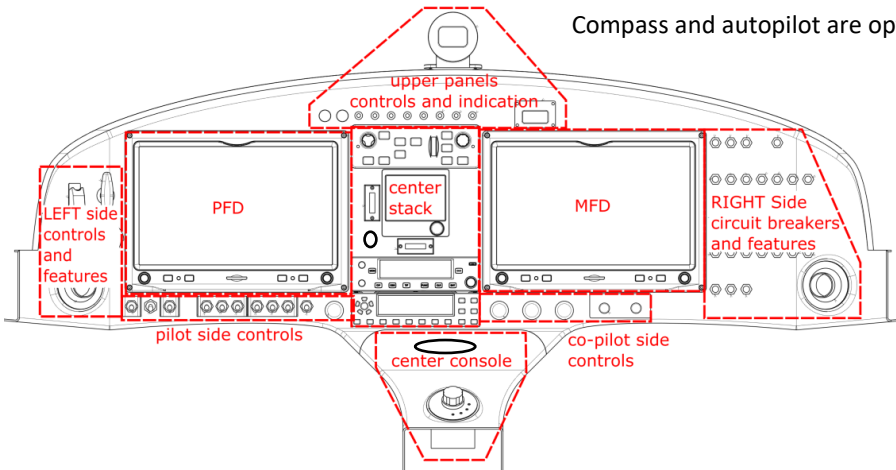

7.4.1 Upper panel controls and indication

On the upper centre panel annunciator lights are mounted from left to right

- Dimmer for glareshield light
- Dimmer for flap system and intercom LED and warning/caution/indication LED (not External power).
- RED, EMS master warning
- AMBER, EMS master caution
Master warning and caution illuminate with related relevant warning or caution triggered by the Garmin system - for details check Garmin PFD and MFD displays.
- AMBER; LOW FUEL Left
- AMBER; LOW FUEL Right
The low fuel light is triggered with less than 6liter usable fuel in the respective tank. This system is electrically independent of the fuel QTY indication. In case of conflicting information landing is advised as soon as practical.
- GREEN; Fuel pump ON
The fuel pump ON light is triggered by the power supply to the electric pump – actual pump function of pressure built up must be checked using the fuel pressure indication.
- GREEN; Landing light ON
The landing light on is triggered by the landing light power supply in both, WIG/WAG and ON mode.
- GREEN; Pitot Heat ON
The pitot heat ON light is triggered by the power supply to the heating element – it does not sense actual current or temperature built up. This must be checked in pre-flight inspection.
- BLUE; External Power ON
The external power ON light is triggered by the connected external power. Never taxi with the External power light illuminated.

Failure of the dimmer unit or its power supply results in inoperative warning/caution and indication lights. Power supply can be restored with the back-up battery.

Document No.: ADXC-73-001-AFM	Non-approved page	Revision: A
	7-8	Date of Issue: 01.10.2020

7.4.2 Left side instrument panel

- Controls
 - Back up battery: guarded switch, must be opened to activate
 - Choke: pull & rotate ON / rotate & push OFF;
 - Ignition switch: OFF/Left/Right/Both/Start
- Features
 - Vent outlet; rotate to open and close, adjust for comfort

7.4.3 Pilot side controls

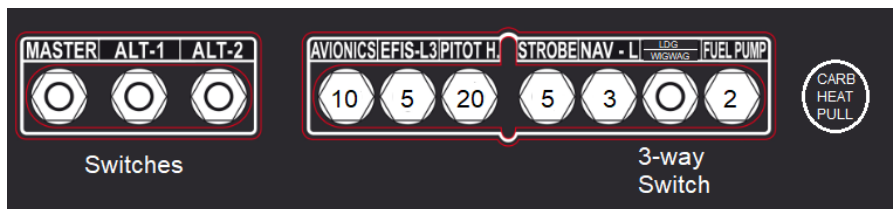

Four groups of controls are located on the lower left instrument panel. Those controls are switches and combined switch circuit breakers

The landing lights are controlled by a three position switch as follows:

- ON (UP)
- WIG/WAG (centre) (left and right light illuminate alternating)
- OFF (DOWN)

7.4.4 Center stack

- Autopilot control unit (optional), refer to 7.14 Avionics
- L-3 EFIS, refer to 7.14 Avionics
- Pitch and roll trim indication
- Day-Night switch controlling brightness of trim indication
- Garmin NAV/COM
- Garmin XPDR

Document No.: ADXC-73-001-AFM	Non-approved page	Revision: A
	7-9	Date of Issue: 01.10.2020

7.4.5 Co-Pilot side controls

- Park break: press pedals to break and pull to lock
- Cabin Heat: pull for heat on.
The cabin heat control must be close in case of engine fire or smoke.
- Up-Down: pull for DOWN, push for UP
the control guides the heated air either to the windshield or to the occupant legs. To defrost the windshield the Cabin heat must be ON and the UP-Down pushed.
- Intercom; refer to 7.14 Avionics

Document No.: ADXC-73-001-AFM	Non-approved page	Revision: A
	7-10	Date of Issue: 01.10.2020

7.4.6 Right side instrument panel

Circuit breakers:

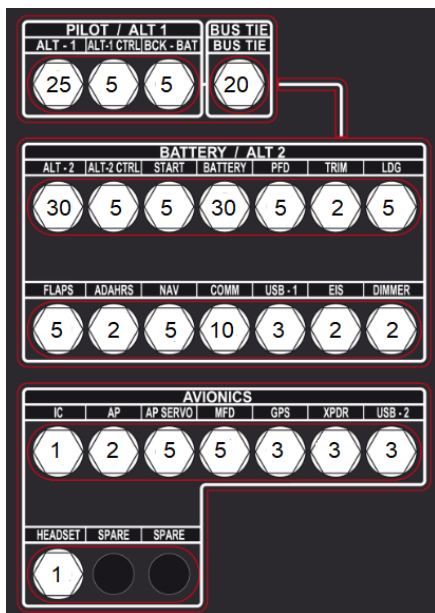

Features:

- Vent outlet; rotate to open and close, adjust for comfort

7.4.7 Control sticks

Both control sticks are equipped with buttons for:

- PTT (at front)
- Trim (and AP disconnect – four way button)
- CWS (control wheel steering which disconnects the AP, front side of grip)
- COM frequency toggle (right grey button on top)
- NAV frequency toggle (left grey button on top)

Pilot / Co-Pilot Aircraft Grip Controls

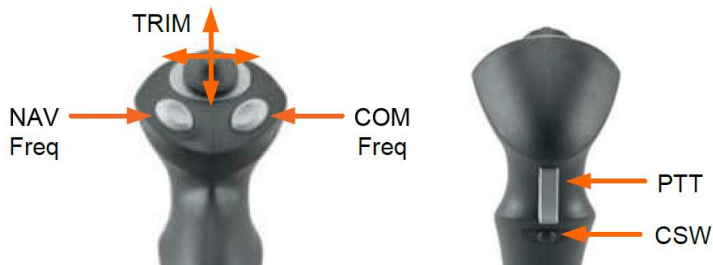

Simultaneous use of trim from both pilot station stops the trim action.

7.4.8 Center console

Below the center panel avionic stack and between the seats a number are a number of controls and features located:

- **AEPS activation handle:**
to activate the AEPS the handle must be pulled with a force of at least 18 to 25kg. At all times the airplane is not in use the handle shall be secured by the securing pin carrying a “remove before flight” flag.
- **Flap control:**
The electronic flap control unit indicates any “in transition mode” by flashing LED’s, permanent illuminated LED indicate the reached position. Reversal of travel direction, respectively change of flap setting can be done any time also during travel. The Flap system has electronic programmed deflections and deflection limits as well as additional travel limit switches.
- **Propeller RPM control:**
The engine power (throttle) and propeller control are mounted on a common rotation axle. A friction system is installed to prevent uncommand power or propeller setting changes. Readjustment of the friction setting is a permissible pilot-owner maintenance action requiring removal of the co-pilot seat pan to gain access to a adjustment nut which can be operated manual.
- **Glove box:**
The glove box allows storage of smaller objects like a torch light for night flying. It can be removed to gain inspection access to some of the main control and flap control system.

Document No.: ADXC-73-001-AFM	Non-approved page	Revision: A
	7-12	Date of Issue: 01.10.2020

- USB power outlets, headset connectors and Bose headset power supply:
are located aft of the glove box between the seat back rests. It is advised to perform any required plug-in or plug-out before boarding.

7.5 Landing gear system

BRISTELL B 23 airplane landing gear is a three-wheel fixed design, that consists of the main landing gear and the nose landing gear. The nose landing gear is steerable. The main landing gear wheels are equipped with hydraulic disc brakes.

7.5.1 Main landing gear

The main landing gear consists of the composite landing gear legs, wheel axle and wheels equipped with disc brakes. The landing gear legs are inserted in the gear channel under the seats, where they are attached using two bolts and a stirrup. Wheels are equipped with tubeless tires. The nominal tyre pressure of the main gear tires is 2.1bar.

7.5.2 Nose landing gear

The nose landing gear is steerable. It consists of a welded steel leg, a steerable wheel fork, a shock absorber (spring and oil damper) and the nose wheel itself. The landing gear is attached to the brackets installed in the nose gear channel located between engine bulkhead and the main wing spar. The wheel is equipped with tubeless tires. The nominal tyre pressure of the nose gear tire is 1.8bar.

7.5.3 Wheel brakes

The airplane is equipped with individual hydraulic disc brakes system for the main landing gear wheels. Brake system consists of the brake pedals (foot tip part of rudder control pedals), brake pumps, hoses for brake fluid supply, brake callipers and brake pads. By pressing pedals, brake pumps are compressed and pressure is generated in the brake circuit and the callipers pushes the brake pads onto the brake discs. Braking pressure can be controlled via brake pedal force.

The airplane is equipped with a hydraulic manually controlled parking brake. It is activated by pressing the brake pedals and pulling the park brake control in the instrument panel.

7.5.4 Wheel fairings

The airplane is equipped with composite wheel fairings that decrease drag and improve aerodynamic properties of the airplane. The wheel fairings are installed onto the brackets by bolts.

NOTE:

Operation without wheel fairings is not approved

Document No.: ADXC-73-001-AFM	Non-approved page	Revision: A
	7-14	Date of Issue: 01.10.2020

7.6 Cockpit lay-out, Seats and safety harness,



Two seats are provided in side by side arrangement. Seats are Kevlar sandwich panels with leather upholstery. The seat pans are held in place by metal clips engaging to the main spar. The seat back rests are held in place by a combination of form fit on the lower end. Seat belts routed through lips at the upper end of the seat back rest. Seats are removable for easier cleaning in the centre fuselage. Side panels are composite sandwich, upholstered in the arm rest area. Map/AFM storage pockets are installed on the side panel.

Seats are equipped with ETSO approved four-point safety harnesses. Safety harnesses consist of two lap straps, two shoulder straps and a safety harness lock. Length of the lap straps and the shoulder straps is adjustable. The shoulder belt are routed through clips on the upper end of the seat back rest.

NOTE

Prior to each flight, ensure that the seat belts are firmly secured to the airframe, and that the belts are not damaged. Adjust the buckle so that it is centred on the body.

Document No.: ADXC-73-001-AFM	Non-approved page	Revision: A
	7-15	Date of Issue: 01.10.2020

7.7 **Baggage compartment**

The rear baggage compartment is located behind the seats. It may accommodate up to 15 kg (33 lb). This space is divided on two sections – baggage compartment A and B. It is prohibited to place heavy items into Baggage compartment B.

The baggage (up to 20 kg (44 lb)) may also be loaded into the baggage compartment inside each wing (wing locker).

CAUTION

Make sure that baggage does not exceed maximum allowable weight, and that the aircraft CG is within limits with loaded baggage.
All baggage must be properly secured.

The baggage in the fuselage compartment is secured by means of a net which is restrained using retinment rings at the four corner points of the luggage compartment



Sharp edge luggage in the wing compartments should be covered with some soft material (folded jacket, cushion) to avoid “jumping” in the wing lockers.

Document No.: ADXC-73-001-AFM	Non-approved page	Revision: A
	7-16	Date of Issue: 01.10.2020

7.8 Cabin

Access to the cockpit is from both sides after opening the canopy. The canopy is suspended on two hinges on the front side of the frame. It is opened fore-/upward. The opening movement is supported by gas springs on each side. The gas springs also keep the canopy in opened position.

NOTE

Engine run with canopy open is possible but not advised due to vibrations. Canopy locking with engine running is hampered by aerodynamic suction forces in opening direction.

The canopy lock for outside access to the aircraft is placed on both sides of the fuselage behind the cockpit bulkhead and below the cockpit frame. It consists of a lever that in closed position neatly fits into the outer fuselage contour. To open the canopy the part of the lever next to the canopy frame has to be pushed, deflecting the lever so that it can be hold and turned around 40° upwards to open the canopy lock.

From inside the canopy lock can also be operated from both sides of the cockpit using hand levers mounted on the side walls just above the map pockets. Connecting all four opening and closing levers is a central torque tube. The system has means to lock by overcentering in fully opened and fully closed position, assuring that no accidental opening occurs during flight.

The cabin is provided with fresh air from ducts on the fuselage side and adjustable vent outlets on either side of the instrument panel.

Heated air is provided from a heat exchanger on the exhaust. The heat exchanger is located on the muffler and supplied with air from NACA inlet located on the left side of the lower cowling. Heated air is supplied into the cockpit by an air hose through a control flap located on the firewall. Quantity of hot air is regulated via the CABIN HEAT push/pull control on the left lower instrument panel. On the cabin side of the firewall is a valve which splits hot air flow into the canopy bubble outlet (UP) and into the crew legs outlet (DOWN). The split usage is controled via the UP/DOWN push pull control next to the cabin heat control.

A glove box is positioned in the middle of the cockpit between the two seats. The composite box can hold only minor mass items

It is closed by a lid. In the inside the emergency exit hammer is stored.

Document No.: ADXC-73-001-AFM	Non-approved page	Revision: A
	7-17	Date of Issue: 01.10.2020

7.9 Powerplant

Standard power unit of BRISTELL B 23 airplane is the ROTAX 912S engine and MTV-34 in flight adjustable 3-blade propeller. Both, engine (EASA-TCDS E.121) and propeller (EASA-TCDS P.049) are certified.

7.9.1 Engine

ROTAX 912S is a 4 stroke, 4 opposed - cylinder engine, central cam shaft and OHV - mechanism with maximal power of 73.5 kW (98.6 hp) at 5800 RPM.

The engine (and fuel system) can be operated on automotive fuel as well as on AVGAS. However, continued use of AVGAS is not recommended by the engine manufacturer.

The recommended power settings for operation are defined in ROTAX SL-912-016R1:

- Engine operation above 5200RPM is not limited by manifold pressure.
- Engine speed over 5500RPM is limited to 5min maximum
- Continuous use of engine speed below 5200RPM must follow pressure graph below
- Note: only applicable on pressure altitude below 3500ft

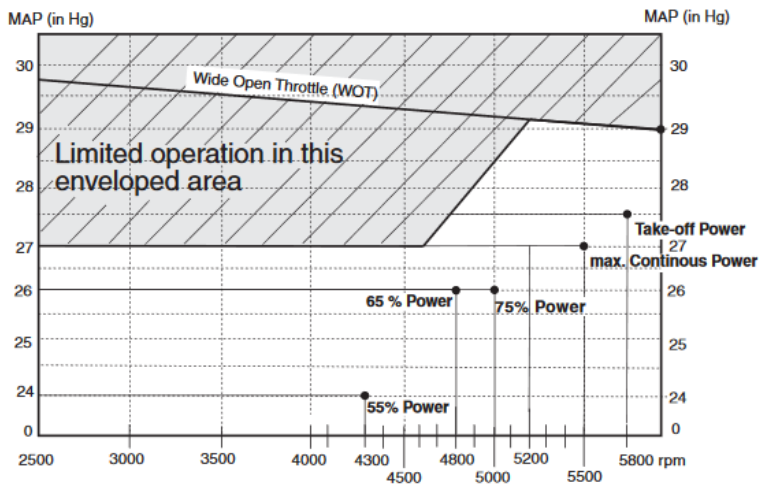

Performance and manifold data for ROTAX® 912 ULS/S

Document No.: ADXC-73-001-AFM	Non-approved page	Revision: A
	7-18	Date of Issue: 01.10.2020

The propeller is driven through a gearbox which has a gearing ratio of 2.43. The propeller speed is 2386 propRPM at an engine speed of 5800 engine RPM.

The fuel consumption of the Rotax engine, dependent on throttle setting, rpm and altitude is up to a maximum of 30liter/hour. Indicated momentary fuel flow can differ significantly especially during transient conditions. Switching the auxiliary fuel pump on will cause the indicated fuel flow to momentary read too high values due to the volumetric change associated with the pressure change. Measured fuel flow is calculated by subtracting the fuel flow in the return line from the fuel flow to the engine. The accumulated tolerances of the sensing as well as the transient conditions make fuel flow indication no trustworthy source for fuel consumption.

The engine installation is equipped with a carburettor pre-heat system drawing hot air from the exhaust heat shield. When selecting Carburettor heat on ground with engine power set to 4000RPM the drop in RPM due to the pre heat is about 200 in ISA conditions and 150 in ISA+20 condition.

In case of performance doubt or marginal weather condition at run up: important is not the RPM drop alone, but the regain of RPM only after carburettor heat is switched off. A regain during carburettor heat on indicates that actual carburettor icing already has happened.

The thermal heat capacity of the engine will heat up all components located in the engine bay after engine shut down. In extreme hot conditions this can lead to vapor formation and a non-functioning fuel pump. Therefore some air of the engine inlet is routed to cool the fuel pump during operation. In any case such occurrence is resolved after cool down. For this reason, short turn around times in hot weather conditions must be performed with care.

Document No.: ADXC-73-001-AFM	Non-approved page	Revision: A
	7-19	Date of Issue: 01.10.2020

7.9.2 Propeller

The propeller MTV-34 is a three-blade in flight hydraulically adjustable wooden-composite propeller designed for light airplanes with piston engines with power up to 86 kW (115 hp) and max. propeller speed up to 2560 rpm.

A CrNi-steel leading edge serves as impact protection. In order to increase service life, the propeller surface has a sprayed-on coat made of resistant polyurethane varnish. The composite propeller spinner is a part of the propeller.

A Jihostroj Velesin governor (P-110-051/A) is installed.

The propeller is attached to the engine using bolts and securing nuts.

Document No.: ADXC-73-001-AFM	Non-approved page	Revision: A
	7-20	Date of Issue: 01.10.2020

7.10 *Fuel system*

Fuel is stored in two fuel tanks. The fuel tanks are integrated part of the wing. Their volume is 60 litres each. The tanks are located in the leading edge of the first third of the outer wing span in front of the main spar. The ribs and rear tank wall are structurally independent from the main spar and wing ribs.

Each fuel tank has a filler neck with flush head filler cap, venting tube, fuel strainer, floater type quantity sensor, low fuel sensor and a drain valve. Fuel is filled into each tank through the filler neck, which is located on the top skin. Fuel drain from the tank is through the drain valve located in the rear corner of bottom skin close to the root fuel tank rib.

Fuel flows from the tank, through fuel strainers to the selector valve and from there through the firewall. On the engine compartment side it flows to the gascolator, electrical fuel pump and finally to the mechanical fuel pump located on the engine. A bypass of the electric pump with a check valve is installed.

From the mechanical pump the fuel is supplied through the fuel distributor lines to the carburetors and to a return line which dumps into the left tank.

The selector valve also serves for interruption of fuel supply in case of engine fire or for airplane long-time parking. The selector is located on the middle console between the seats in the cockpit.

The gascolator is located on the firewall at the lowest point of the fuel system. It features a drain valve to check for contamination and water.

The electrical fuel pump is located on the firewall above the gascolator.

The electric fuel pump not only serves as (emergency) back up for take-off and landing but also to suppress fuel vapor formation in extreme hot and high conditions. It should be switched on for take-off and landing, but also at any time the fuel pressure drops unexpected. Unnecessary fuel pump operation with engine off should be avoided to not overflow the carburetors.

NOTE

Switching the electric fuel pump off causes a transient fuel pressure drop caused by the changed operating point of the mechanical pump – sometimes below the minimum level. This can cause a low fuel pressure warning. The acceptable time limit for this warning (according engine manufacturer) is 5sec.

The operation of the fuel pump upon start up when the strobe lights are switched on is audible influenced by the power surge of the strobe lights.

Document No.: ADXC-73-001-AFM	Non-approved page	Revision: A
	7-21	Date of Issue: 01.10.2020

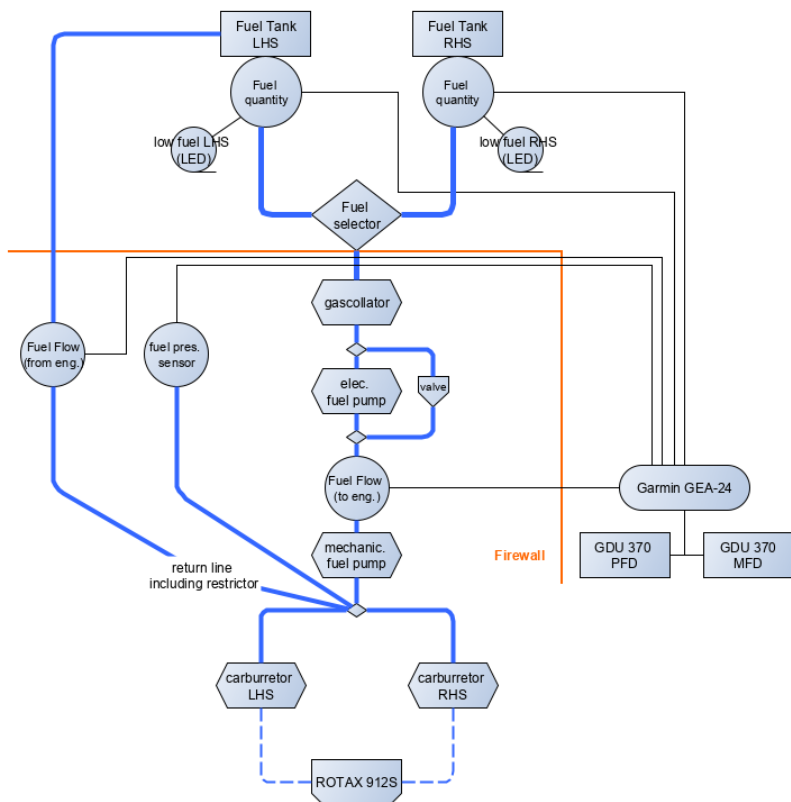

Fuel quantity is measured by the fuel float gauges. The float position is converted to an electrical signal and fuel quantity in the tank is indicated on the PFD/MFD screens. The fuel system also provides an independent hard-wired low fuel warning light in the instrument panel (LED). The low fuel warning illuminated with about 6 litres usable fuel left in the respective tank. The fuel quantity indication by a floater sensor detects the fuel quantity from zero to 45 litres. From 45 to 60 litres (59 liter usable) no detection is given, amount indicated is „+45litres“.

Visual fuel quantity determination in pre-flight inspection is through the filler neck. If the lower wing surface right below the filler neck is wetted

Document No.: ADXC-73-001-AFM	Non-approved page	Revision: A
	7-22	Date of Issue: 01.10.2020

with fuel the amount in the tank equals to about 12 litres. Using a ruler or “Fuel Hawk” tube the actual quantity above 12 litres can be determined:

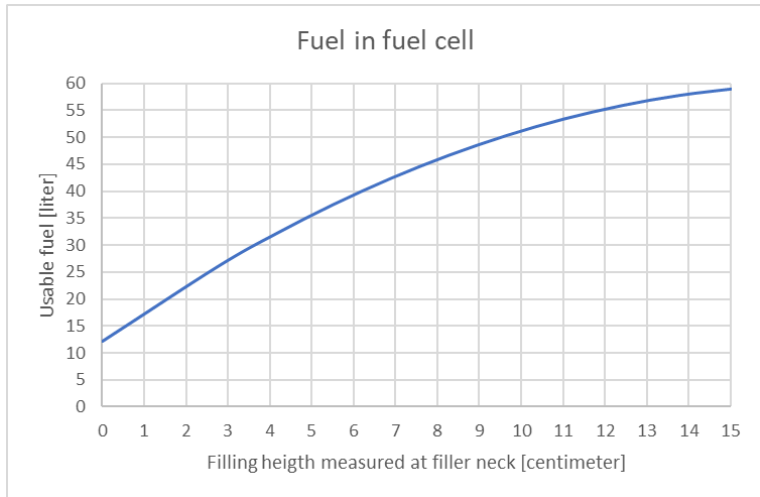

The fuel vents end at the wingtips where a little scoop provides some RAM pressure.

The fuel quantity indication is to a minor extent dependent on the aircraft attitude. Readings of quantity are calibrated in normal ground attitude. In nose up attitude (slow speed/climb) the indication is slightly higher in nose down (Flap down/high speed/decent). The total effect is about +/-2 litres over the range of normal in flight attitude.

Designated ground bonding (electric discharge) point during re-fuelling is the exhaust end pipe.

Document No.: ADXC-73-001-AFM	Non-approved page	Revision: A
	7-23	Date of Issue: 01.10.2020

7.11 **Electrical system**

The airplane is equipped with 14V DC electrical installations with grounded negative pole. Primary source of electrical power are two generators. The secondary source of electrical energy is a 12 V battery, located on the firewall. It is used for starting the engine, as buffer and as a source of electric energy in the case of generator failure. Further electric power is furnished by a back-up battery to the essential indications of the Garmin system and the glareshield light. The L3-EIS features its own separate internal back-up battery.

Three busses are defined

- 1.) PILOT BUS / ALT1 which is powered from - Alternator 1
- 2.) BATT / ALT2 which is powered from Alternator 2 and the Battery
A normally closed bus tie circuit breaker links the two busses
- 3.) AVIONICS BUS which is powered via the „Avionics switch“ from the PILOT BUS

Document No.: ADXC-73-001-AFM	Non-approved page	Revision: A
	7-24	Date of Issue: 01.10.2020

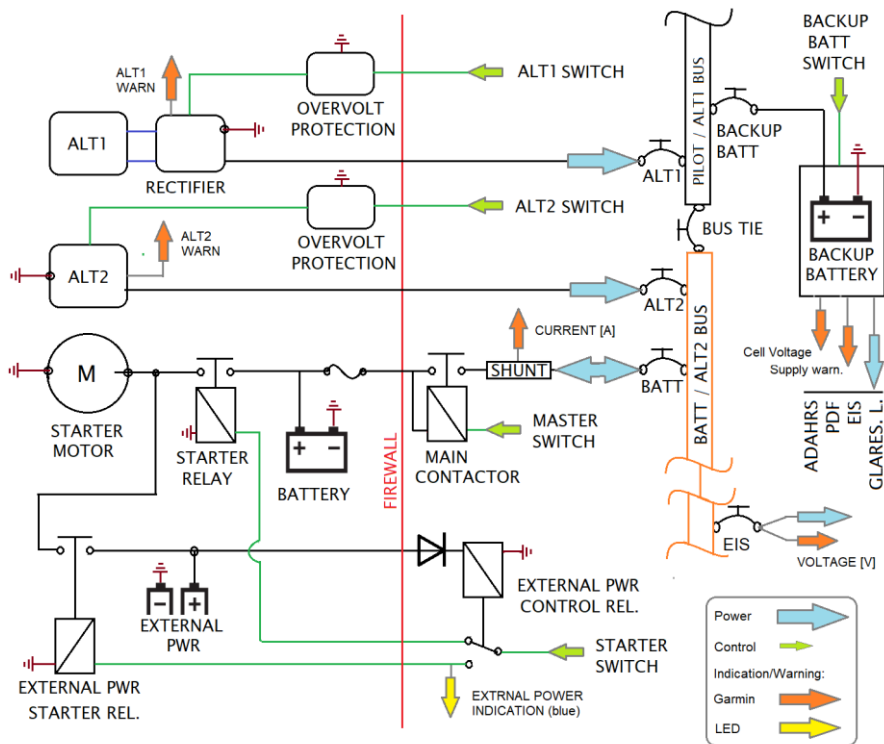

Systems are protected by circuit breakers, which are permanently on. On the PILOT/ALT1 BUS also combined switches-circuit breakers are used.

After switching the master switch on and by turning the ignition key to the "START" position the starter is activated. The starter is supplied from the battery. After starting up the engine and reaching the idle RPM, the generators are switched on and start supplying current to the electrical network.

Information about voltage [V] and current [A] are indicated on Garmin engine page. The voltage indication is tapped from the EIS circuit breaker and related to BATT / ALT2 Bus. The current signal is tapped from the battery feeder line and displays negative values for current flowing from the battery to the bus system. Positive values indicate charging. Zero indication is a fully charge and balanced situation.

Document No.: ADXC-73-001-AFM	Non-approved page	Revision: A
	7-25	Date of Issue: 01.10.2020

Alternator caution is triggered by either a actual failure of the alternator but also by failure of the respective alternator control power supply. Therefore the alternator caution also turns on when the alternator is not switched on.

Overvoltage protection units are installed in either alternator line.

The supply to the back-up battery is monitored by the back-up battery itself. It triggers a caution is the supply voltage drops below 11Volt.

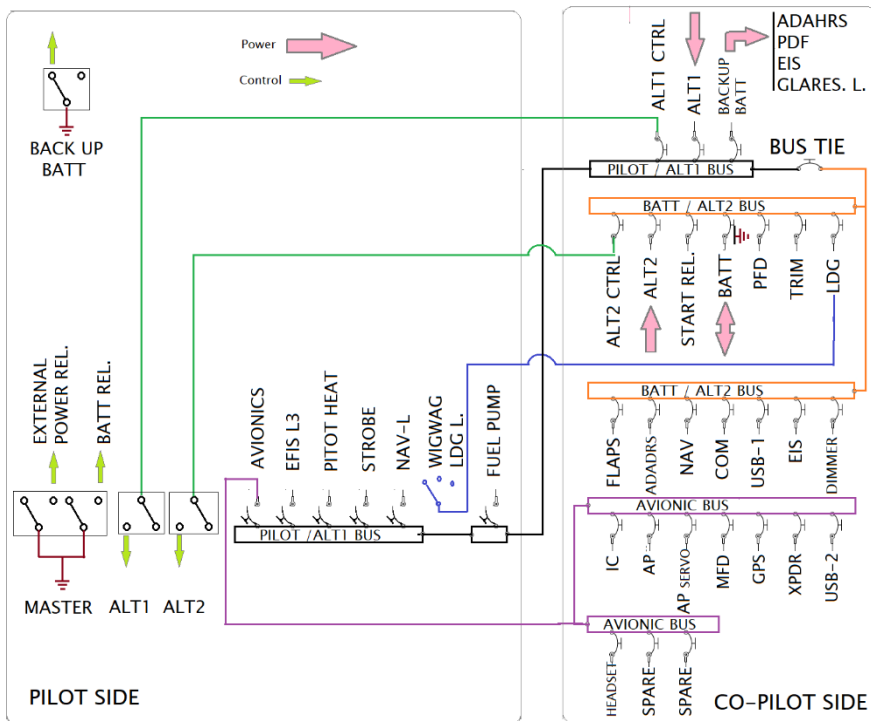

The correlation of consumers and supplying part of the bus system allows continued safe flight and landing with a partial bus system failure:

Consumer	Pilot/ALT1 Bus		Batt/Alt2 Bus
	Avionic Bus		
L3		d	
Pitot Heat		s	
Strobe L.		s	
NAV L.		s	
WIGWAG; LDG L.			s
Fuel Pump		s	
<i>Backup batt</i>		s	
Starter (Rel.)			s
PFD			d
Trim			s
Flaps			s
ADAHRS		d	
NAV			s
COM			s
USB-1			s
EIS			d
DIMMER			d
Intercom	s		
Autopilot*	s		
Autopilot Servo*	s		
MFD	s		
GPS	s		
XPDR	s		
USB-2	s		
Headset	s		

s = single supply d = dual supply (through back-up battery)

* = option

The installed USB power outlets are intended for occupant personal electronic devices (PED) and can supply 1000mA and 2100mA as indicated on the outlet. The pilot is responsible for the compatibility of the PED with the aircraft on board system. In case of doubt: don't use PED's.

7.11.1 Warning, caution and indication lights, internal lighting

There are two major streams of information to the pilot:

- Warnings and cautions displayed on the Garmin system
- Hardwired information

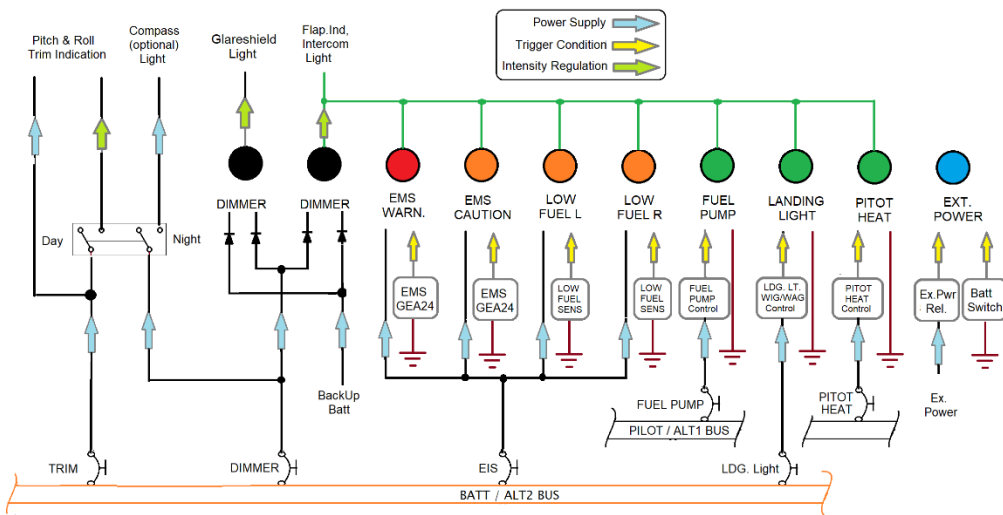

The functionality of the indication lights depends on the respective power supply AND the power to the dimming unit.

Cockpit lighting is provided by a dimmable glareshield light. Light intensity of indication lights is regulated independently. The control knob for the glareshield dimmer is on the left end of the dimmer/indication light row. Intensity increased when rotated clockwise.

A second dimmer control is next in the row what dims the LED indication lights. Intensity is reduced when rotated clockwise.

Document No.: ADXC-73-001-AFM	Non-approved page	Revision: A
	7-28	Date of Issue: 01.10.2020

NOTE:

“Day” position for both dimmers is fully turned anti-clockwise

Loosing power on either bus and/or on the EIS CB leads to partial loss of the information. Restoring power by means of the Back-Up battery does restore the function of the EMS unit (GEA24), and the power input to the indication light control.

Instrument lighting is mainly provided by the respective screens, refer to the avionic section.

A further feature of the internal light system is the Day/Night switch located in the centre panel. The switch reduces the brightness of the trim indication for night operation to a fixed value and switched ON the compass light (optional, if installed).

7.11.2 Use of back-up battery

The power input to the consumers which can be fed from the back-up battery (ADHRS/PFD/EIS/Glareshield light/Indication light intensity control) is separated from the regular power input by means of diodes. The consumer will utilize the power which provides the higher voltage. So, in order to make sure the back-up battery is actually used (and main battery energy is conserved for other functions) the pilot has to pull the CS's of ADHRS, PFD, EIS and Dimmer.

This in turn means the functionality of low fuel warning and the indication light dimming function is not available.

Document No.: ADXC-73-001-AFM	Non-approved page	Revision: A
	7-29	Date of Issue: 01.10.2020

7.11.3 External lighting

External lights are individual selectable

- Wing leading edge mounted landing lights
- Wing tip mounted position lights incorporating also
- Anti-collision lights

All three types of light have their own circuit. In case of severe electric system failures partial external lighting can be restored after pulling the BUS-TIE CB, refer to chapter 7.11.

The landing lights have two operational modes controlled by the 3position switch

- WIG/WAG mode which alternates on/off of the left and right light for better in-flight recognition by other aircraft.
- Landing light mode which switches both lights permanently on for landing and taxi operation.

There is no time/temperature limit on either light.

Document No.: ADXC-73-001-AFM	Non-approved page	Revision: A
	7-30	Date of Issue: 01.10.2020

7.11.4 External Power

The functionality of the external power is limited to supply the engine starter motor and the indication light. The external power cannot be used for re-charging.

The external power plug is located on the lower side of the firewall on the engine side left of the nose landing gear. It is accessible through the large air-dump opening of the lower cowling.

WARNING

The external power connection and disconnection is only possible with the outside person temporarily out of sight from pilot station. If an outside person is used a clear coordination before the operation between the pilot and the outside help is mandatory. The outside person is advised to always keep one hand on the left wing leading edge as visible sign to the pilot of a safe position. Under no circumstances the outside person shall move other than along the leading edge when engine is running. Removal of the external power connection with engine running is not advised.

The voltage supplied to the external power must be in the range of 12 to 14Volt for correct operation. Incorrect polarity of the external power supply is protected by a control diode.

The continuous current capacity of the external power plug is 50Amps which is usually exceeded during engine start attempts. Therefore, even with unlimited electric supply the time of start attempts must be limited.

CAUTION

The starter should be activated for a maximum of 10 sec., followed by 2 min. pause for starter, starter circuit and external power connection cooling.

Document No.: ADXC-73-001-AFM	Non-approved page	Revision: A
	7-31	Date of Issue: 01.10.2020

7.12 Pitot and static pressure systems

The Garmin GAP-26 Heated Pitot Tube with AOA (angle of attack) is located under the right wing.

The total pressure is sensed through the hole in the pitot-tube face.

Static pressure ports are located on both sides of the fuselage, at the tail.

Pressure distribution to individual instruments is performed by means of flexible plastic hoses.

Static and total pressure is lead to Garmin ADHARS unit and the approved L3-ESI 500 indicator with independent airdata computer.

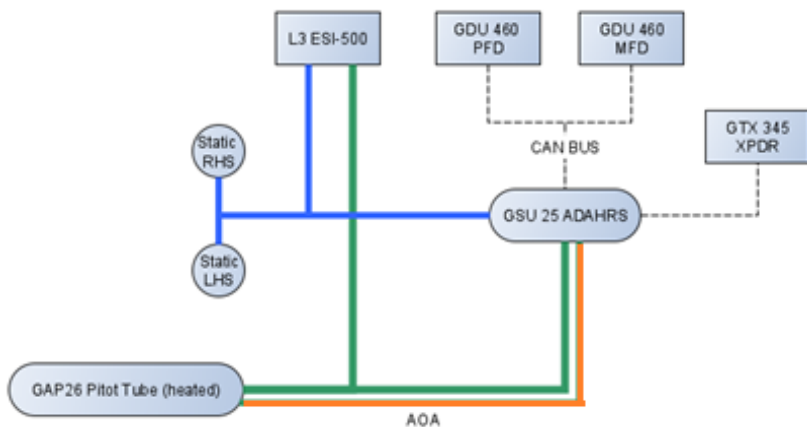

The static ports are located left and right on the aft part of the fuselage side wall.

NOTE

Pitot/Static and AOA pressure ports and lines are subject to insect nesting and should be covered whenever the airplane is not operated

Drain provisions (maintenance action) are provided by spring loaded valves.

- for the pitot as well as the AOS sensing between the centre wing and left outer wing (removal of wing root cover needed),
- for the static system on the fuselage belly

Document No.: ADXC-73-001-AFM	Non-approved page	Revision: A
	7-32	Date of Issue: 01.10.2020

7.13 *Miscellaneous equipment*

7.13.1 Stall warning system

The stall warning employed on this airplane is programable in the G3X and uses AOA as well as normal and pitch acceleration (G3X system). It is set to warn the pilot of approaching stall at about 5kts above stall speed

7.13.2 Airframe emergency parachute system

The B23 is equipped with a BRS-5 ballistic system which can be used in situations where continued safe flight is impossible and immediate danger for the occupants is imminent. The recovery system deployment sets the aircraft into an almost horizontal condition with slight nose down attitude. The system is mechanically activated by the pilot or from the occupant seat.

WARNING

Make sure the safety pin of the handle is engaged at all times that the airplane is not operated.

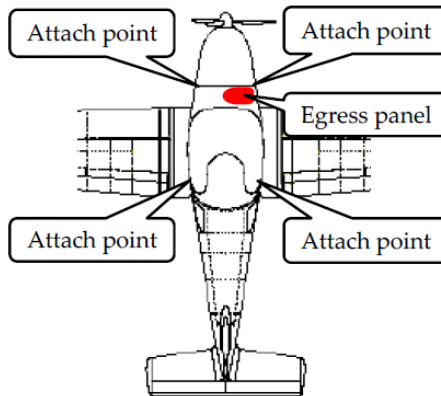

7.14 Avionics

The Avionics system sytem installed in the B23 is compromized of panel mounted and remote mounted units of the G3X system as well as a stand alone L-3 EFIS. Comon interface between the two systems are only pitot and staic pressure sources. An overview is given in Figure 1. Various unis are powered from various sources, see chapter 7.11

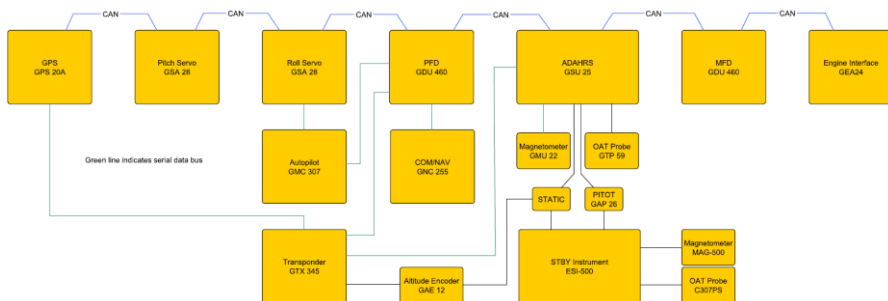
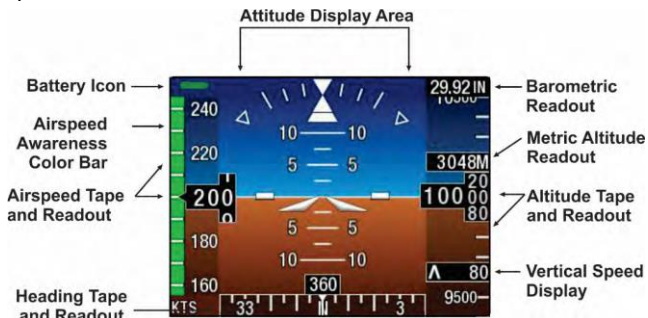

Figure 1: Avionic System overview

Document No.: ADXC-73-001-AFM	Non-approved page	Revision: A
	7-34	Date of Issue: 01.10.2020

7.14.1 L-3 EFIS, L3 ESI-500

The L3 EFIS provides indication of knots indicated airspeed, heading, roll-pitch-attitude, vertical speed (ft), pressure altitude (ft) or optionally in meter (m), barometric correction, selected course for display and slip/skid information.



Basic operation

The MicroSD-card slot must be empty before booting. The ESI-500 does not have a power ON Switch. The device boots when switching on an electric power source of the aircraft. After booting splash screen, the device begins with aligning attitude which may require a couple of minutes to complete. In that time, the aircraft must not be shaken or moved. After alignment is complete, the unit is in normal operation mode.

To shut down the ESI-500, all electric power sources of the aircraft must be shut down. A warning “Press Menu button for Back-up battery mode” appears. After 5 min, the device shut down automatically. To speed up the shut down, press menu button, then select and confirm BATT shutdown.

Adjust barometric pressure by rotating the knob when the pilot menu is not active. Milibars (MB) and Hectopascals (hPa) are adjusted in increments of 1.0 and inches of Mercury (IN) are adjusted of 0.01. Press the knob to set the standard barometric setting (29.92 In.Hg, 1013 hPa, 1013 mb) when the menu is not active. The barometric display will indicate “STD”.

Document No.: ADXC-73-001-AFM	Non-approved page	Revision: A
	7-35	Date of Issue: 01.10.2020

Pilot menu

After pressing the menu button the menu points can be selected by the rotary switch and confirmed by pressing the rotary switch. The menu structure is:

- BATT Shutdown
- Data Field
 - TAS
 - OFF
 - OAT
- Set BRT Trim (brightness)
- Metric ALT
- Align Attitude
- BATT Calibration
- System Status

Emergency operation

If all electric power sources of the aircraft collapse, the warning “Press Menu button for Back-up battery mode” appears, the menu button must be pressed within the next 5 min. Alternatively, press and hold the Menu button for approximately 10 seconds to start the ESI-500 with internal back-up battery power.

On back-up power, the ESI-500 has a run time capacity for a green battery indicator of at least 1 hour.

Abnormal occurrences

During flight, if air data is not failed and the “HDG DEGRADED” indication is displayed, cross check the heading with another source or outside reference. Return to straight and level until the message clears for full performance

During flight, if air data is failed and “HDG DEGRADED” indication is displayed, cross check the heading with another source or outside reference.

Document No.: ADXC-73-001-AFM	Non-approved page	Revision: A
	7-36	Date of Issue: 01.10.2020

Basic settings for operations

Increase display brightness: When the pilot menu is not active, pressing and holding the menu button will increase the display brightness. Use the pitot menu item “Set brightness Offset” to adjust the brightness.

Limitations

Internal back-up battery operation can be inhibited due to low voltage or exceeding the battery temperatur limits of -20°C or $+60^{\circ}\text{C}$.

When air data failed, the ESI-500 can operate in an Attitude Degraded Mode, indicated as amber “ATT DEGRADED” message, which means that the ESI-500 is not operating within the normal performance parameters. When air data failed, heading is invalid.

If the roll value is greater than 11.5° for three minutes or the “ATT DEGRADED” is shown, the heading degraded operation occurs and the heading indication has a lesser performance, shown by the amber “HDG DEGRADED” message.

The use of heading is authorized to operate in the following limits: generally 70° S to 70° N latitude, North of 65° N lattitude between 75° and 120° W longitude (northern Canada), South of 55° S latitude between 120° and 165° E longitude (south of australia and New Zealand)

For detailed information see L3 ESI-500 Electronic Standby Indicator Pilots Guide, Document No. 0040-15000-01 Rev.B, dated November 16, 2015 (or later FAA approved revision).

Document No.: ADXC-73-001-AFM	Non-approved page	Revision: A
	7-37	Date of Issue: 01.10.2020

7.14.2 Garmin PFD / MFD screens

In this AFM only the basic features of the Garmin touch display installation are explained. For the full range of options, settings, flight planning and accessible information refer to the Garmon G3X pilot guide.

The Garmin GDU460 displays (pilot+co-pilot) features PFD, MFD and splitscreen mode



On Battery bus on the pilot side goes into full screen PFD mode with a (selectable) map insert and EIS on side bar. After switching on the Avionic bus the co-pilot side goes full screen MFD mode. The EIS side bar changes from pilot to co-pilot side.

Several screen options can be selected on either side, independent from the other side.

On pilot side display failure the PFD is added to the co-pilot display which goes in split screen mode.

Document No.: ADXC-73-001-AFM	Non-approved page	Revision: A
	7-38	Date of Issue: 01.10.2020

BATT ON
FULL SCREEN

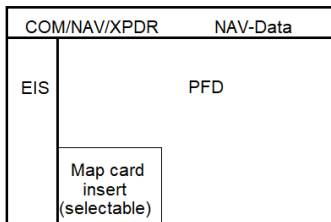

BATT ON
AVIONIC ON
FULL SCREEN

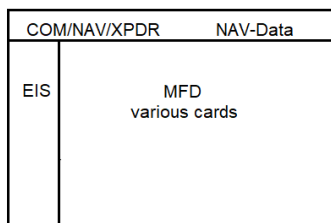
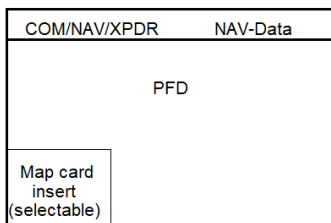

SELECTABLE
SPLIT SCREEN

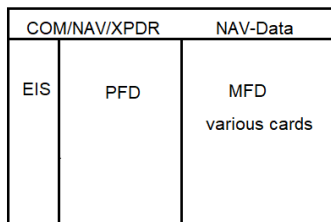
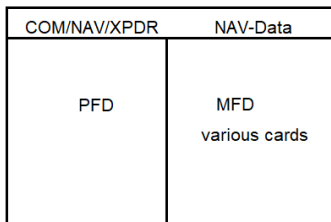

DISPLAY
FAILURE

Co-Pilot side failure

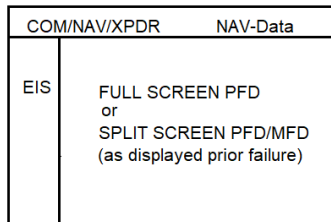

Pilot side failure

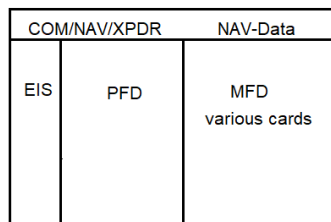



AIRCRAFT FLIGHT MANUAL

BRISTELL B23

NRST Key	Press to display the Nearest Page for viewing the nearest airports, intersections, NDBs, VORs, waypoints, frequencies, and airspaces
Direct-To Key	Press to activate the Direct-To function, enter a destination waypoint and establish a direct-to course to the selected destination
MENU Key	Press once to view the Page Menu Press twice to view the Main Menu Press a third time to clear the Main Menu Press and hold to save a screenshot to the SD Card
BACK Key	Press to return to the previous screen Press and hold to return to the default MFD Page Press and hold to toggle between full-screen and split-screen modes
Knobs	<p>The display unit knobs are highly customizable and can be configured for a variety of functions, especially for PFD functions. The two options that configure the PFD knobs are found in the PFD Setup menu. On the PFD display unit, press the MENU button and touch the More Options... on-screen button.</p> <p>The "main" PFD knobs are by default on the left-hand side of the display, and "alternate" knobs on the right. This can be changed by pressing the MENU key twice and touching the PFD icon, then changing PFD Split Screen Side from Right to Left.</p> <p>By default the main inner knob will adjust the HSI's heading bug, and the main outer knob will adjust the altitude bug. The alternate inner knob will adjust the HSI course selection (in OBS mode), and the alternate outer knob will adjust the local barometric pressure setting.</p>

Basic operation

The Pilots PFD is launch by switch on any electric power source, the co-pilots MFD is lauch by switching on the avionics toggle. During booting the ADAHRS is aligning. The AHRS can align itself both while taxiing and during level flight. Generally the pilot side launch into the PFD, while the co-pilot side display

Adjust the barometric pressure by turning the large right Knob associated with the PFD to set the barometric pressure. The barometric pressure setting is displayed below the Altimeter in inches of mercury (in Hg) or hectopascals (hPa).

Document No.: ADXC-73-001-AFM	Non-approved page	Revision: A
	7-40	Date of Issue: 01.10.2020

Stall warning, angle of attack indicator

The AoA displays next the attitude indicator with increasing AoA, which output an aural warning when reaching the allowable AoA.

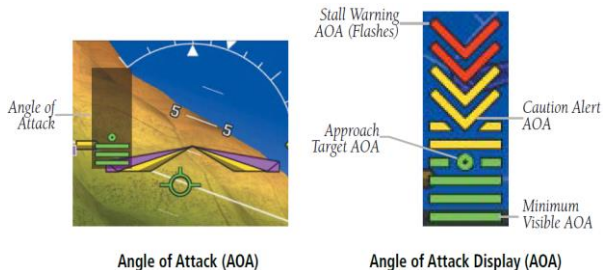

EIS

The EIS indicates manifold pressure (inHg), engine speed (RPM), oil pressure (bar), oil temperature (°C), cylinder head temp. (°C), exhaust gas temp. (°C), fuel quantity (litre) and fuel pressure (bar). The indicator are furnished with markings of optimum ranges (green), non-optimum or caution ranges (amber) and limits (red line). Warning and cautions are indicated as highlighted labels and messages in PFD.

Display-Modes

Selectable main pages are: Map Page (Map), Charts Page (Cht), Waypoint Page (Wpt), Active Flight Plan Page (FPL), Terrain Page (Ter), Info Page (Info) and Engine Page (Eng).

For splitting the display into several pages: Press Split or Full in the upper left or right hand corner of the display to toggle between split and full screen. Or, press and hold the BACK Key to toggle between split and full screen.

NOTE

See Garmin G3X Touch Pilots Guide for further features:
Barometric pressure settings, Altitude alerting, Flight Director, Glide path indication, horizontal situation indicator, course deviation indicator, G-meter, vertical navigation, GPS navigation, Flight planning, Hazard avoidance, synthetic vision, data logging, SD-Cards usage, etc.

Document No.: ADXC-73-001-AFM	Non-approved page	Revision: A
	7-41	Date of Issue: 01.10.2020

7.14.3 Garmin GMC 307-20 Autopilot control panel (optional)

The GMC 307-20 is part of the Garmin AUTOMATIC FLIGHT CONTROL SYSTEMS (AFCS) and provides a user interface for the autopilot function of the G3X system. Aileron and elevator control and trim are interfaced by the AFCS. The rudder control is not interfaced. Especially in high power climb configuration the pilot must correct the lateral control for best performance.

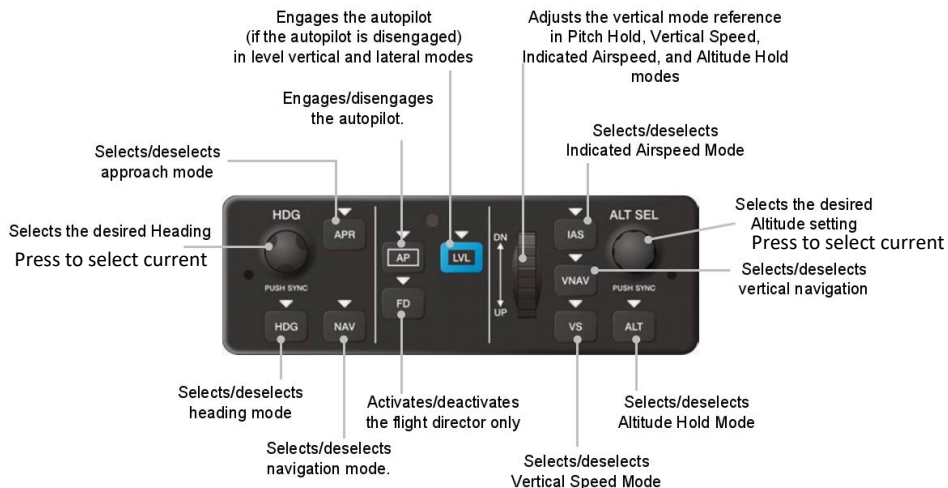

Basic operations

Flight Director (FD) commands are displayed on the PFD, which provides: Command Bars showing pitch/roll guidance, Vertical/lateral mode selection and processing, Autopilot communication. With the flight director active, the aircraft can be hand-flown to follow the path shown by the Command Bars. For setting the FD, press the MENU Key of the PFD1 twice to display the Main Menu, then touch Setup and Flight Director.

Autopilot (AP) provides servo monitoring and automatic flight control in response to flight director steering commands, Air Data and Attitude and Heading Reference System (ADAHRS) attitude, rate information, and airspeed.

The Autopilot is manually disengaged by pushing the disconnect button on the autopilot unit, by pressing the autopilot disconnect button on the

Document No.: ADXC-73-001-AFM	Non-approved page	Revision: A
	7-42	Date of Issue: 01.10.2020

control stick (CWS), by pressing any trim button or by pressing the AP Key on the GMC 307.

NOTE

In case of trim system failure (loss of power to trim system) the AP disconnect by trim button is also inoperative

Manual disengagement is indicated by a five-second flashing yellow 'AP' annunciation and an aural alert. Cancel the aural alert by pressing and releasing the AP/CWS Button again (GSA 28 autopilot only) Automatic disengagement is indicated by a flashing red 'AP' annunciation and an aural alert. Touch to acknowledge. Automatic disengagement occurs due to: System failure, Invalid sensor data or Inability to compute default autopilot modes.

A small amount of pressure or force on the pitch controls can cause the autopilot automatic trim to run to an out-of-trim condition. Therefore, any application of pressure or force to the controls should be avoided when the autopilot is engaged. Overpowering the autopilot during flight will cause the autopilot's automatic trim to run, resulting in an out-of-trim condition or cause the trim to hit the stop if the action is prolonged. In this case, larger than anticipated control forces are required after the autopilot is disengaged.

Abnormal occurrences

If an autopilot failure or trim failure is suspected to have occurred, perform the

following steps:

- 1) Firmly grasp the control stick.
- 2) Press and hold the AP DISC Switch. The autopilot will disconnect and power is removed from the trim motor. Power is also removed from all primary servo motors and engaged solenoids. Note the visual and aural alerting indicating autopilot disconnect.
- 3) Retrim the aircraft as needed. Substantial trim adjustment may be needed.
- 4) Pull the appropriate circuit breaker(s) to electrically isolate the servo and solenoid components.
- 5) Release the AP DISC Switch.

Document No.: ADXC-73-001-AFM	Non-approved page	Revision: A
	7-43	Date of Issue: 01.10.2020

Envelope protection, Electronic Stability & Protection (ESP-X)

ESP monitor the aircraft and provide control input feedback when necessary to discourage operating the aircraft at potentially unsafe attitudes and/or airspeeds. If enabled (which is the default setting), this feature will automatically arm when the aircraft is above 500 feet AGL and the autopilot is not engaged, and disarm when below 200 feet AGL. When selected, ESP engages automatically when the aircraft approaches or exceeds one or more predetermined airspeed or attitude limitations. NOTE: If AGL height data is unavailable (i.e., GPS altitude or terrain data is unavailable), automatic engagement of Level mode is not supported. Stability protection for each flight axis is provided by the autopilot servos, which apply force to the appropriate control surface(s) to discourage pilot control inputs that would cause the aircraft to exceed the normal or "protected" flight envelope. This is perceived by the pilot as resistance to control movement in the undesired direction when the aircraft approaches a steep attitude, and/or the airspeed is below the minimum or above the maximum configured airspeed. As the aircraft deviates further from the normal attitude and/or airspeed, the force increases proportionally (up to an established maximum) to encourage control movement in the direction necessary to return to the normal attitude and/or airspeed range. When ESP has been engaged for more than fifteen seconds (cumulative; not necessarily consecutive seconds) of a 30-second interval, the autopilot can be configured to engage with the flight director in Level Mode, bringing the aircraft into level flight. An aural "Autopilot" alert is played and the flight director mode annunciation will indicate 'LVL' for vertical and lateral modes. Level mode as activated by ESP is limited by altitude. ESP will not be able to activate Level mode until the aircraft climbs above 2000 feet AGL. ESP will be locked out of automatically activating Level mode after the aircraft descends below 1500 feet AGL as well. Also note that Level mode as activated by ESP is different than manually selected Level mode. Manually selected Level mode is not limited by altitude at all. The pilot can interrupt ESP by pressing and holding the Autopilot Disconnect / Control Wheel Steering (AP DISC / CWS) switch. Upon releasing the AP DISC / CWS switch, ESP force will again be applied. ESP can also be overridden by overpowering the servo's torque limit. ESP is enabled or disabled from the Automatic Flight Control System page

- 1) From the PFD, touch the Autopilot Status Box. The Automatic Flight Control System page is displayed.
- 2) Touch the ESP button on the Automatic Flight Control System page to enable/disable ESP.

Document No.: ADXC-73-001-AFM	Non-approved page	Revision: A
	7-44	Date of Issue: 01.10.2020



AIRCRAFT FLIGHT MANUAL

BRISTELL B23

NOTE

See Garmin G3X Touch Pilots Guide for details and further features:
Pitch Hold Mode (PIT), Selected Altitude Capture Mode (ALTS), Vertical
Speed Mode (VS), Indicated Airspeed Mode (IAS).

Document No.: ADXC-73-001-AFM	Non-approved page	Revision: A
	7-45	Date of Issue: 01.10.2020

7.14.4 Garmin GNC 255 COM/NAV

The GNC 255 COM/NAV combines VHF communications transceiver with 200 channel and VOR. Besides traditional NAV/COM features, the GNC 255 also incorporates workload-reducing functions such as automatic decoding of the Morse code station identifier for VOR/LOC, most-used frequency storage in memory, built-in course deviation indicator, and more.

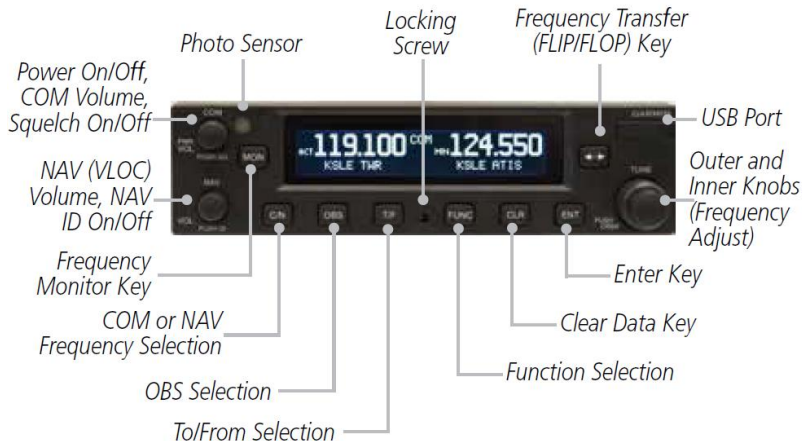

GNC 255 Front Panel Description

NOTE

Refer to GARMIN GNC 255A/255B Pilot's Guide for detailed product description, operation, and functions.
Basic operation of GNC 255 is provided on next pages.

Document No.: ADXC-73-001-AFM	Non-approved page	Revision: A
	7-46	Date of Issue: 01.10.2020

Selecting a COM frequency

New frequencies are first selected as a standby frequency and then toggled to the active side with the **FLIP/FLOP** key. While viewing the standby frequency display, use the outer and inner knobs on the right side of the GNC 255 to select the desired frequency.



Identifier and Type

Asterisk Indicates Multiple Types Exist For The Selected Frequency

COM Frequency Selection

1. Press **C/N**, if necessary, to reach the COM radio function. The COM annunciator on the top line of the display will show.
2. Turn the outer knob to change the values in one MHz increments. The MHz selection range is between 118 and 136 in one MHz steps.
3. Turn the inner knob to change the values in 25 kHz or 8.33 kHz increments. The kHz selection range is between 000 and 975 kHz in 25 kHz steps or 000 and 990 kHz in 8.33 kHz steps.
4. Turn the outer and inner knobs clockwise to increase and counterclockwise to decrease the frequency values. Standby frequency selection is not inhibited during transmit.
5. When connected to a position source, the nearest station identifier will be shown for the selected frequency. Frequencies with multiple types will have an asterisk next to the identifier.
6. Press and release the **FLIP/FLOP** key to toggle the standby frequency to the active frequency.

Document No.: ADXC-73-001-AFM	Non-approved page	Revision: A
	7-47	Date of Issue: 01.10.2020

Monitoring the Standby Channel



COM Frequency Monitor Annunciation

The Frequency Monitoring function allows you to monitor the standby frequency for activity, while listening to the active frequency.

Press the **MON** key in the COM function to listen to the standby frequency. A small “MN” will replace the “STB” to the left of the standby frequency.

When the active frequency receives a signal, the unit will switch automatically to the active frequency. The active frequency quality is not affected. The Frequency Monitor function is turned off by pressing the **MON** key again. Monitoring is not canceled by switching to NAV mode.

Saving a COM Channel

The current standby frequency may be saved into the COM User Frequency database from the COM display or the COM User Function. The COM User Frequency database can hold up to fifteen frequencies.



NOTE: When switching from 8.33 kHz to 25 kHz mode, any 8.33 kHz-specific user frequencies will be deleted from the user frequency list. This only affects the user frequencies within the 8.33 kHz spectrum.



COM User Frequency Name Selection

1. Press **ENT**.
2. Turn the inner knob to select characters.
3. Turn the outer knob to move the cursor.
4. After selecting characters, press **ENT**.
5. Turn the outer knob to select the waypoint type.
6. Turn the inner knob to select the type from the list.
7. Press **ENT** to save displayed value.
Press **CLR** to cancel the changes.

Document No.: ADXC-73-001-AFM	Non-approved page	Revision: A
	7-48	Date of Issue: 01.10.2020

7.14.5 Garmin GTX 345 transponder

The GTX 345 includes ADS-B In functionality, when connected to a suitable display.

GTX 345 Features:

- ADS-B Out
- Dual-band ADS-B In traffic display output and aural alerting
- Integration with TCAD/TAS/TCAS I traffic systems
- FIS-B weather and flight information display output
- Bluetooth interface provides traffic, weather, and attitude data to a Portable Electronic Device (PED)
- Altitude deviation alerting
- Timers: count up, count down, flight, trip
- Static (Outside) air temperature display
- Density and pressure altitude display
- Internal GPS (Optional)

Panel mount Transponder controls

The GTX 3X5 series transponders have an auto-dimming display and keypad layout. The keys access the transponder's controls and features.



- ON** Powers on, disables altitude reporting.
- ALT** Powers on, enables altitude reporting.
- VFR** Changes to the preprogrammed squawk code for VFR.
- OFF** Powers off.
- SBY** Powers on or changes into standby mode.
- IDNT** Activates the Ident function.

NOTE

Refer to GARMIN GTX 335/345 Series All-In-One ADS-B Transponder Pilot's Guide for detailed product description, operation, and functions.

Document No.: ADXC-73-001-AFM	Non-approved page	Revision: A
	7-49	Date of Issue: 01.10.2020

7.14.6 Intercom

A PM3000 Intercom is installed.



Basic operations

The volume control knob adjusts the loudness of the intercom and does not affect the volume level of the aircraft radio. By turning the control clockwise, the audio level will increase simultaneously.

With the engine running, set the squelch control knob by slowly rotating the squelch control knob clockwise until you no longer hear the background noise in the earphones. When the microphone is positioned properly near the lips, normal speech levels should open the channel. When you have stopped talking, there is a delay of about one half second before the channel closes. This prevents squelch closure between words, and helps eliminate choppy intercom conversations.

Both pilot and copilot have transmit capabilities over the radio. The PM3000 only allows the voice of the person who presses their PTT (Push To Talk) to be transmitted over the aircraft radio. If both pilot and copilot press the PTT at the same time, the copilot will override. When either pilot or co-pilot presses PTT, all other microphones are disabled. The pilot can regain priority by switching the unit off.

Mode ISO (Isolate): The pilot is isolated from the intercom and is connected only to the aircraft radios. He will hear the aircraft radio reception (and sidetone during radio transmissions).

Mode ALL: Pilot and Co-pilot hear each other and a/c radio

Pressing the squelch knob mutes the Entertainment Input (unused feature). Pressing the Volume knob switches the intercom on/off.

Document No.: ADXC-73-001-AFM	Non-approved page	Revision: A
	7-50	Date of Issue: 01.10.2020

Abnormal occurrences

In case of failure of the intercom power supply normal radio transmission and reception on the pilot side is still possible. However, this functions not in stereo but only on one channel of the headset

Document No.: ADXC-73-001-AFM	Non-approved page	Revision: A
	7-51	Date of Issue: 01.10.2020

SECTION 8

8 AEROPLANE HANDLING, SERVICING AND MAINTENANCE

8.1	<i>Introduction</i>	8-1
8.2	<i>Aeroplane inspection periods</i>	8-1
8.3	<i>Aeroplane alterations or repairs</i>	8-2
8.4	<i>Ground handling</i>	8-3
8.4.1	Towing	8-3
8.4.2	Parking	8-3
8.4.3	Mooring	8-3
8.5	<i>Cleaning and care</i>	8-5
8.5.1	Painted exterior surfaces	8-5
8.5.2	Propeller	8-5
8.5.3	Engine	8-5
8.5.4	Interior surfaces, seats and carpets	8-5

8.1 Introduction

This section contains factory-recommended procedures for proper ground handling and servicing of the aeroplane. It also identifies certain inspection and maintenance requirements which must be followed if the aeroplane is to retain that new-plane performance and dependability. It is wise to follow a planned schedule of lubrication and preventive maintenance based on climatic and flying conditions encountered.

8.2 Aeroplane inspection periods

Maintenance of the aircraft is performed according the referenced documents below:

Airframe:

ADxC-73-001-AMM Airplane Maintenance Manual

Engine:

Maintenance Manual (Line Maintenance) for ROTAX Engine Type 912 Series, Chapter 05-20-00 Scheduled Maintenance Tasks.

Propeller:

OPERATION , INSTALLATION and MAINTENANCE MANUAL for MTV-34 propeller.

BRS AEPS Parachute:

Installation and user's manual, Ballistic rescue parachute systems series

Other installed equipment:

Refer to the manuals and/or other documents supplied with installed equipment for inspection periods, if any.

Document No.: ADXC-73-001-AFM	Non-approved page	Revision: A
	8-1	Date of Issue: 01.10.2020

8.3 *Aeroplane alterations or repairs*

Alterations or repair are no pilot action!

It is essential that all alterations on the aeroplane are based on approved data and executed by authorized personnel and organizations to ensure that airworthiness of the plane is not violated.

Approved data for repairs is subject to be published.

Always use only the original spare parts produced by the airplane (engine, prop) manufacturer.

Approved data for alterations (beyond CS-Stan changes) must be received through the type design holder AD&C EASA DOA 21.J.411 or any other qualified entity.

If the aircraft weight is affected by an alternation, a new weighing is necessary. In such a case, record the new empty weight into the Weight and Balance record / Permitted payload range in SECTION 6

Document No.: ADXC-73-001-AFM	Non-approved page	Revision: A
	8-2	Date of Issue: 01.10.2020

8.4 Ground handling

8.4.1 Towing

To handle the airplane on the ground, use the Tow Bar, or the fuselage rear pushed down in the place of a bulkhead.

CAUTION

Avoid excessive pressure at the airplane airframe-especially at control surfaces. Keep all safety precautions, especially in the propeller area.

8.4.2 Parking

It is advisable to park the airplane inside a hangar or alternatively inside any other suitable space with stable temperature, good ventilation, low humidity and dust-free environment.

It is necessary to moor the airplane when it is parked outside a hangar. Also when parking for a long time, cover the cockpit canopy, possibly the whole airplane by means of a suitable tarpaulin.

8.4.3 Mooring

The airplane should be moored when parked outside a hangar after the flight day. The mooring is necessary to protect the airplane against possible damage caused by wind and gusts.

For this reason, the aircraft is equipped with tie-down points located on the lower surfaces of the wings. The installation is a pan-fitting ring which can be swiveled up for flight and down for parking and mooring.

Mooring procedure:

1. Flaps up
2. All electric switches off
3. Fuel Selector shut off
4. Fix the controls. For control stick fixation use safety harness.

NOTE

Locking controls on the pilot side means that ground gust loads on control surfaces will be transmitted through the entire control system potentially causing non detected damage. Therefore locking at the control surface with adequate locks featuring "remove before flight" warning is recommended

5. Close air vents
6. Close and lock canopy
7. Cover static ports and pitot tube

Document No.: ADXC-73-001-AFM	Non-approved page	Revision: A
	8-3	Date of Issue: 01.10.2020

8. Moor the aircraft to the ground by means of a mooring rope passed through the tie-down points.

NOTE

In case of long term parking, especially during winter, it is recommended:

- * to cover the cockpit canopy or possibly the whole aircraft by means of a suitable tarpaulin attached to the airframe.
- * to adhere to engine conservation procedures.

Document No.: ADXC-73-001-AFM	Non-approved page	Revision: A
	8-4	Date of Issue: 01.10.2020

8.5 *Cleaning and care*

8.5.1 Painted exterior surfaces

Use efficient cleaning detergents to clean the aircraft surface. Oil spots on the aircraft surface (except the canopy!) may be cleaned with gasoline.

The canopy may only be cleaned by washing it with a sufficient quantity of lukewarm water and an adequate quantity of detergents. Use either a soft, clean cloth sponge or deerskin. Then use suitable polishers to clean the canopy.

CAUTION

Never clean the canopy during “dry” conditions and never use gas or chemical solvents!

8.5.2 Propeller

For propeller cleaning refer to the OPERATION, INSTALLATION and MAINTENANCE MANUAL for MTV-34 propeller, 7.0 MAINTENANCE.

8.5.3 Engine

For engine cleaning refer to the Maintenance Manual (Line Maintenance) for ROTAX Engine Type 912 Series, Chapter: 12-20-00, SCHEDULED MAINTENANCE.

8.5.4 Interior surfaces, seats and carpets

Upholstery and covers may be removed from the cockpit, brushed and eventually washed in lukewarm water with an adequate quantity of detergents. Dry the upholstery thoroughly before insertion into the cockpit.

Document No.: ADXC-73-001-AFM	Non-approved page	Revision: A
	8-5	Date of Issue: 01.10.2020

SECTION 9

9 SUPPLEMENTS

9.1	<i>Introduction</i>	9-1
9.2	<i>List of inserted supplements.....</i>	9-2
9.3	<i>Supplements inserted.....</i>	9-3

9.1 *Introduction*

This section contains the appropriate supplements necessary to safely and efficiently operate the aeroplane when equipped with various optional systems and equipment not provided with the standard aeroplane.

Document No.: ADXC-73-001-AFM	Non-approved page	Revision: A
	9-1	Date of Issue: 01.10.2020

9.2 List of inserted supplements

Date	Doc. No.	Title of the inserted supplement

9.3 *Supplements inserted*